

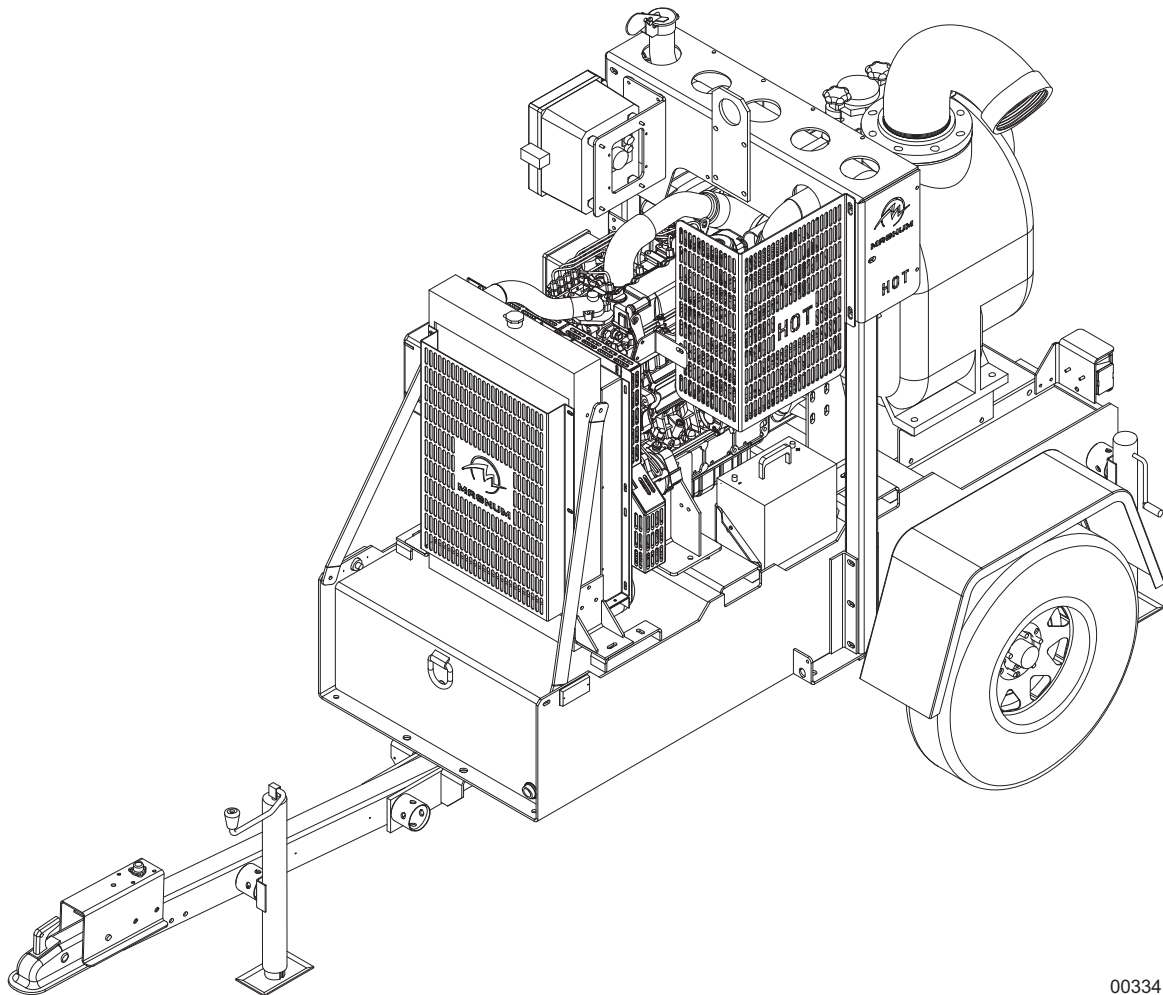

SELF-PRIME DIESEL TRASH PUMP MTP6000SKI4P



00334

OPERATING MANUAL

Parts manuals available online! www.m-p-llc.com

INTRODUCTION

This manual provides information and procedures to safely operate and maintain the Magnum Power Products LLC unit. For your own safety and protection from physical injury, carefully read, understand, and observe the safety instructions described in this manual. Keep a copy of this manual with the unit at all times. Additional copies are available from Magnum Power Products LLC, or can be found at www.m-p-llc.com. *The information contained in this manual was based on machines in production at the time of publication. Magnum Power Products LLC reserves the right to change any portion of this information without notice.*

Read all of the manuals included with the unit. Each manual details specific information regarding items such as setup, use and service requirements. An engine operator's manual provides detailed operation and maintenance procedures for the engine. Additional copies of the engine operator's manual are available from the engine manufacturer.

DO NOT MODIFY or use this equipment for any application other than which it was designed for.

Magnum Power Products LLC recommends that a trained and licensed professional perform all electrical wiring and testing functions. Any wiring should be in compliance with the National Electrical Code (NEC), state and local codes and Occupational Safety and Health Association (OSHA) guidelines.

MAGNUM POWER PRODUCTS LLC

215 Power Drive • Berlin, WI 54923

U.S.A.

Phone: 920-361-4442

FAX: 920-361-4416

Toll Free: 1-800-926-9768

www.m-p-llc.com

For technical or parts **QUESTIONS**, please contact the Magnum Power Products LLC Customer Support or Technical Support team at 1-800-926-9768. Please have your serial number available.

To **ORDER SERVICE PARTS**, please contact the dealer from which you purchased the unit, or call Magnum Power Products LLC to locate a dealer in your area.

Engine Make: _____

Engine Serial Number: _____

Engine Model Number: _____

Pump Make: _____

Pump Model Number: _____

Pump Serial Number: _____

Unit Model Number: _____

Unit Serial Number: _____

▲ WARNING

CALIFORNIA PROPOSITION 65 WARNING: Diesel engine exhaust and some of its constituents are known to the state of California to cause cancer, birth defects and other reproductive harm.

TABLE OF CONTENTS

	Page
INTRODUCTION	2
SAFETY NOTES	6
OPERATING SAFETY	6
ENGINE SAFETY	7
PUMP SAFETY	7
SERVICE SAFETY	8
TOWING SAFETY	8
REPORTING TRAILER SAFETY DEFECTS	9
UNIT SERIAL NUMBER LOCATIONS	9
SAFETY SYMBOL SUMMARY	10
SPECIFICATIONS	11
COMPONENT LOCATIONS	12
CONTROL PANEL	14
CONTROL PANEL OPERATION	15
THROTTLE CONTROL	16
RAMP THROTTLE (SPEED CONTROL SWITCH)	16
MECHANICALLY GOVERNED ENGINES	16
AUTOMATIC START/STOP OPERATION	16
CANPLUS DISPLAY	18
ANALOG GAUGE PAGES	18
DIGITAL GAUGE PAGES	19
SINGLE ANALOG GAUGE	19
ANALOG TRANSDUCER/SWITCH GAUGE	20
DIGITAL TRANSDUCER GAUGE	20
ACTIVE ALARMS	20
ALARM LIST	20
CONFIGURATION	20
CONFIGURATION MENU	21
DISPLAY MENU	21
SYSTEM MENU	23
AUTOSTART MENU	28
SETTINGS MENU	30
TELEMETRY MENU	32
DB VIEWER	33
PREFERRED SCREEN STORE	33
POP-UP MESSAGES AND ALERTS	33
ADJUSTING LIGHTING AND CONTRAST	34
INDICATORS	34
DATA PARAMETERS MONITORED	35
PUMP PRE-USE CHECKPOINTS	37
PUMP SET UP	38
STARTING THE PUMP	40
SUCTION SPECIFICATIONS	42
LIQUID TEMPERATURE AND OVERHEATING	42
PUMP VACUUM CHECK	42
BEARING TEMPERATURE CHECK	42
STOPPING THE PUMP	43
AUTOMATIC SHUTDOWN	43
REMOTE/AUTO STARTING OPTION	43
TOWING THE TRAILER	43
TRAILER WHEEL BEARINGS	44
LIFTING THE PUMP	44
DAILY WALK AROUND INSPECTION	44
ENGINE AND PUMP MAINTENANCE	44
BASIC MAINTENANCE SCHEDULE (KUBOTA ENGINE)	45
SERVICING THE UNIT	46

PUMP DISASSEMBLY	47
REASSEMBLY OF PUMP COMPONENTS	50
PUMP LUBRICATION	52
STORAGE	52
PRODUCT FLUSH OPTION	53
PUMP TROUBLESHOOTING	54
ENGINE FAULT SHUTDOWN TROUBLESHOOTING	55
CONTROL SYSTEM TROUBLESHOOTING	56
PUMP COMPONENTS	57
DC WIRING DIAGRAM	58
TRAILER LIGHTS WIRING DIAGRAM	59
BRAKE WIRING DIAGRAM	60
SERVICE LOG	61
NOTES	62

This Page Intentionally Left Blank

SAFETY NOTES



This is the safety alert symbol. It is used to alert you to potential personal injury hazards. Obey all safety messages that follow this symbol to avoid possible injury or death.

This manual contains DANGERS, WARNINGS, CAUTIONS, NOTICES and NOTES which must be followed to prevent the possibility of improper service, damage to the equipment, personal injury or death. The following formatting options will apply when calling the readers attention to the DANGERS, WARNINGS, CAUTIONS, NOTICES and NOTES.

▲ DANGER

INDICATES A HAZARDOUS SITUATION WHICH, IF NOT AVOIDED, WILL RESULT IN DEATH OR SERIOUS INJURY.

▲ WARNING

Indicates a hazardous situation which, if not avoided, could result in death or serious injury.

▲ CAUTION

Indicates a hazardous situation which, if not avoided, could result in minor or moderate injury.

NOTICE

Indicates a hazardous situation which, if not avoided, could result in property or equipment damage.

Note: Note: Notes contain additional information important to a procedure and will be found within the regular text body of this manual.

OPERATING SAFETY



Before using the pump be sure you read and understand all of the instructions. This equipment was designed for specific applications; **DO NOT** modify or use this equipment for any application other than which it was designed for. Equipment operated improperly or by untrained personnel can be dangerous. Read the operating instructions and familiarize yourself with the location and proper use of all instruments and controls. Inexperienced operators should receive instruction from someone familiar with the equipment before being allowed to operate or set up the pump. The following points should be practiced at all times:

- The area immediately surrounding the pump should be dry, clean, and free of debris.
- Position and operate the pump on a firm, level surface.
- **NEVER** start a unit in need of repair.
- **NEVER** modify the pump or use it in a manner other than for what it was designed.
- **DO NOT** start the pump if any panels or guards are loose or missing.
- Move the engine start switch to the "OFF" position when servicing or troubleshooting.
- Use hearing protection if you will be near an operating pump for an extended period of time.
- Keep clear of pump suction and discharge openings while pump engine is running.
- Keep all body parts, loose clothing and any other obstructions away from moving parts.
- **NEVER** operate the unit while tired, distracted, or under the influence of drugs or alcohol.

ENGINE SAFETY



Internal combustion engines present special hazards during operation and fueling. Failure to follow the safety guidelines described below could result in severe injury or death. Also read and follow all safety warnings described in the engine operator's manual. A copy of this manual was supplied with the unit when it was shipped from the factory.

- **DO NOT** run engine indoors or in an area with poor ventilation unless exhaust hoses are used. Diesel engine exhaust contains carbon monoxide, a deadly, odorless and colorless gas which, if inhaled, can cause nausea, fainting or death. Make sure engine exhaust cannot seep into closed rooms or ventilation equipment.
- **DO NOT** fill fuel tank near an open flame, while smoking, or while engine is running. **DO NOT** fill tank in an enclosed area with poor ventilation.
- **DO NOT** operate with the fuel tank cap loose or missing.
- **DO NOT** operate on a combustible surface.
- **DO NOT** touch or lean against hot exhaust pipes or engine block.
- **DO NOT** clean air filter with gasoline or other types of low flash point solvents.
- **DO NOT** remove engine coolant cap while engine is hot.
- **DO NOT** operate the unit without a functional exhaust system. Prolonged exposure to sound levels in excess of 85 dB(A) can cause permanent hearing loss. Wear hearing protection when working around a running engine.
- Keep hands, feet and loose clothing away from moving parts on the pump and engine.
- Keep area around exhaust pipes and radiator free of debris to reduce the chance of an accidental fire.
- Batteries contain sulfuric acid, which can cause severe injury or death. Sulfuric acid can cause eye damage, burn flesh or eat holes in clothing. Protective eye wear and clothing are necessary when working on or around the battery. Always disconnect the negative (-) battery cable from the corresponding terminal before performing any service on the engine or other components.
- Shut down the engine if any of the following conditions exist during operation:
 1. Noticeable change in engine speed.
 2. Loss of pumping output.
 3. Sparking occurs.
 4. Engine misfires or there is excessive engine or pump vibration or noise.

PUMP SAFETY



Centrifugal pumps are designed for specific applications and may not be suited for other uses without loss of performance or potential damage to equipment/personnel. If there is any doubt about suitability for a specific purpose; contact Magnum Power Products LLC for assistance. Follow the safety guidelines described below to prevent hazardous situations which could result in severe injury or death.

- This pump is designed to handle mild industrial corrosives, residues, and slurries containing some large entrained solids. Do not attempt to pump volatile, corrosive, or flammable materials that may damage the pump or endanger personnel as a result of pump failure.
- After the pump has been positioned, make certain that the pump and all hose/piping connections are tight, properly supported, and secure before operation.
- **DO NOT** operate the pump without the guards in place over the rotating parts. Exposed rotating parts can catch clothing, fingers, or tools, causing severe injury to personnel.
- **DO NOT** remove plates, covers, gauges, pipe plugs, or fittings from an overheated pump. Vapor pressure within the pump can cause parts being disengaged to be ejected with great force. Allow the pump to cool before servicing.

- **DO NOT** operate the pump against a closed discharge valve for long periods of time. If operated against a closed discharge valve, pump components will deteriorate, and the liquid could come to a boil, build pressure, and cause the pump casing to rupture or explode.
- Remove suction and discharge hoses/piping from pump prior to moving. Use lifting and moving equipment with adequate capacity and in good repair.
- **NEVER** exceed the maximum permissible operating pressure of the pump as shown on the pump performance curve.
- If equipment is stored more than 12 months, some of the components or lubricants may have exceeded their maximum shelf life. These must be inspected and replaced as necessary prior to pump operation to ensure proper pump performance.

SERVICE SAFETY



All service work must be performed by qualified personnel who are familiar with the equipment. Only a qualified electrician should troubleshoot or repair electrical problems occurring in this equipment. Follow the safety guidelines described below to prevent hazardous situations which could result in severe injury or death.

- Before servicing the trash pump, make sure the engine start switch is turned to OFF and the negative terminal on the battery is disconnected. **NEVER** perform even routine service (oil/filter changes, cleaning, etc.) unless all electrical components are shut down.
- **NEVER** service electrical components if clothing or skin is wet. If the unit is stored outside, check the engine for any moisture and dry the unit before use.
- **NEVER** open the radiator cap or oil drain plug while the engine is running or before the engine has cooled down. Pressurized coolant and hot engine oil can cause severe burns. Allow the engine and pump to cool completely before attempting any service work.
- Check the temperature before opening any pump covers, plates or plugs. Allow the pump to cool if overheated.
- Before servicing the pump end, close the suction and discharge valves. Vent the pump slowly and cautiously. Drain the pump completely.
- **NEVER** attempt to modify the engine, pump or related components.
- **NEVER** wash the unit with a power washer or high pressure hose.
- Replace all guards and safety devices immediately after servicing.
- Replace all missing and hard-to-read labels. Labels provide important operating instructions and warn of dangers and hazards.
- Make sure slings, chains, hooks, ramps, jacks, and other types of lifting devices are attached securely and have enough weight-bearing capacity to lift or hold the equipment safely. Always remain aware of the position of other people around you when lifting the equipment.

TOWING SAFETY



Towing a trailer requires care. Both the trailer and vehicle must be in good condition and securely fastened to each other to reduce the possibility of an accident. Also, some states require that large trailers be registered and licensed. Contact your local Department of Transportation office to check on license requirements for your particular unit.

- Check that the hitch and coupling on the towing vehicle are rated equal to, or greater than, the trailer's Gross Vehicle Weight Rating (GVWR).
- Check tires on trailer for tread wear, inflation, and condition.
- **NEVER** tow the trailer using defective parts. Inspect the hitch and coupling for wear or damage.
- Make sure the trailer hitch and the coupling are compatible. Make sure the coupling is securely fastened to the vehicle.

- Connect safety chains in a crossing pattern under the tongue and **ATTACH THE BREAKAWAY CABLE TO THE REAR BUMPER OF THE TOWING VEHICLE**. Do not attach the cable to the trailer hitch.
- Make sure directional and brake lights on the trailer are connected and working properly.
- Check that all lug nuts holding wheels on are tight and that none are missing.
- Maximum recommended speed for highway towing is 45 mph (72 km/h). Recommended off-road towing speed is not to exceed 10 mph (16 km/h) or less, depending on terrain.

The trailer is equipped with hydraulic surge brakes or electric surge brakes. Check the operation of the brakes by braking the vehicle at a slow speed before entering traffic. Both the trailer and the vehicle should brake smoothly. If the trailer seems to be pushing, check the level in the surge brake fluid reservoir.

When towing, maintain extra space between vehicles and avoid soft shoulders, curbs, and sudden lane changes. If you have not pulled a trailer before, practice turning, stopping, and backing up in an area away from heavy traffic.

A film of grease on the coupler will extend coupler life and eliminate squeaking. Wipe the coupler clean and apply fresh grease each time the trailer is towed.

REPORTING TRAILER SAFETY DEFECTS

If you believe your trailer has a defect which could cause a crash or could cause injury or death, you should immediately inform the National Highway Traffic Safety Administration (NHTSA) in addition to notifying Magnum Power Products LLC.

If NHTSA receives similar complaints, it may open an investigation; and if it finds that a safety defect exists in a group of vehicles, it may order a recall and remedy campaign. However, NHTSA cannot become involved in individual problems between you, your dealer, or Magnum Power Products LLC.

To contact NHTSA, you may either call the Auto Safety Hotline toll-free at 1-888-327-4236 (TTY:1-800-424-9153), go to <http://www.safercar.gov>; or write to:

Administrator
NHTSA
1200 New Jersey Avenue S.E.
Washington, DC 20590

You can also obtain other information about motor vehicle safety from <http://www.safercar.gov>.

UNIT SERIAL NUMBER LOCATIONS

Refer to the illustration to locate the unit ID tag and Vehicle Identification Number (VIN) tag on the unit. Important information, such as the unit serial number, model number, VIN and tire loading information are found on these tags. Record the information from these tags so it is available if the tags are lost or damaged. When ordering parts or requesting assistance, you may be asked to provide this information.

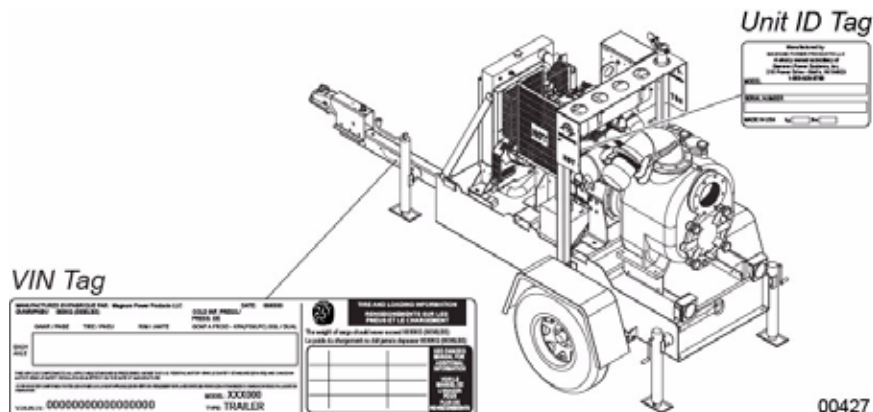

SAFETY SYMBOL SUMMARY

This equipment has been supplied with numerous safety and operating decals. These decals provide important operating instructions and warn of dangers and hazards. Replace any missing or hard-to-read decals and use care when washing or cleaning the unit. Decal placement and part numbers can be found in the parts manual. Below is a summary of the intended meanings for the symbols used on the decals.

	Safety alert symbol; used to alert you to potential personal injury hazards.		Asphyxiation hazard; operate in well ventilated area.
	Hot surface(s) nearby.		Hazardous voltage. Disconnect battery before servicing.
	Belt/entanglement hazard; keep body parts clear of this area.		Anchor/tie down point.
	Rotating fan hazard; do not operate without guards in place. Keep body parts clear of this area.		Burn/scald hazard; pressurized steam.
	Rotating impeller blade hazard; keep body parts clear of this area.		Use clean diesel fuel only.
	Moving parts can crush and cut; keep body parts clear of this area.		Remove negative battery cable before performing any service on unit.
	Stop engine before fueling.		Read and understand the supplied operating manual before operating unit.
	Hearing protection required while operating unit.		Lift here only.
	Fire/explosion hazard; keep open flames away from unit.		

00335

SPECIFICATIONS

MAGNUM MODEL

MTP6000SKI4P

Engine:

Make/Brand, Model	Kubota, V3600E3BKEA3
Type	Diesel, liquid cooled, 4-stroke
Displacement in ³ (L)	221 (3.6)
Cylinders - qty	4
Eng Rated Speed rpm	2600
Eng Pwr @ Rated Speed - Int. hp (kW)	66.8 (49.8)
Eng Operating Speed rpm	2200
Eng Pwr @ Oper. Speed - Int. hp (kW)	63.7 (47.5)
Fuel Consumption - 100% load gph (Lph)	2.9 (11)
Battery Type - Group Number	24
Battery Voltage (Quantity per Unit)	12V (1)
Battery Rating	720 CCA
Alternator Rating	60A

Pump:

Make/Brand	Pioneer Pump Inc.
Model	ES6
Fitting Size	6" NPTF
Impeller Material	ASTM A536 Ductile Iron
Impeller Diameter in (mm)	11.50 (292)
Shaft Material	Lasalle Stressproof (modified AISI 1144 stl)
Volute Material	ASTM A536 Ductile Iron
Wear Plate Material	ASTM A536 Ductile Iron

Pump Set (Engine/Pump):

Maximum Diameter of Solids in (mm)	3.0 (76.2)
Maximum Pump Output gpm (Lpm)	1720 (6510)
Maximum Lift Suction ft (m)	28 (8.5)
Maximum Operating Speed rpm	2300
Total Dynamic Head ft (m)	135 (41)
Sound dB(a) 23 ft. @ prime	80

Dimensions (LxWxH):

Skid Mounted in (m)	82 x 35 x 60 (2.08 x 0.89 x 1.52)
Trailer Mounted in (m)	138 x 57 x 78 (3.51 x 1.45 x 1.98)

Weights:

Dry Weight, Skid Mounted lbs (kg)	2792 (1266)
Operating Weight, Skid Mounted lbs (kg)	3584 (1626)
Dry Weight, Trailer Mounted lbs (kg)	3342 (1516)
Operating Weight, Trailer Mounted lbs (kg)	4134 (1875)

Capacities:

Fuel Tank Volume gal (L)	110 (416)
Usable Fuel Volume gal (L)	95 (360)
Maximum Run Time hrs	34

Trailer:

Number of Axles	1
Capacity - Axle Rating lbs (kg)	5000 (2268)
Tire Size in	15
Brakes	Surge
Hitch - Standard	2" Ball
Maximum Tire Pressure psi	65

Specifications are subject to change without notice.

COMPONENT LOCATIONS

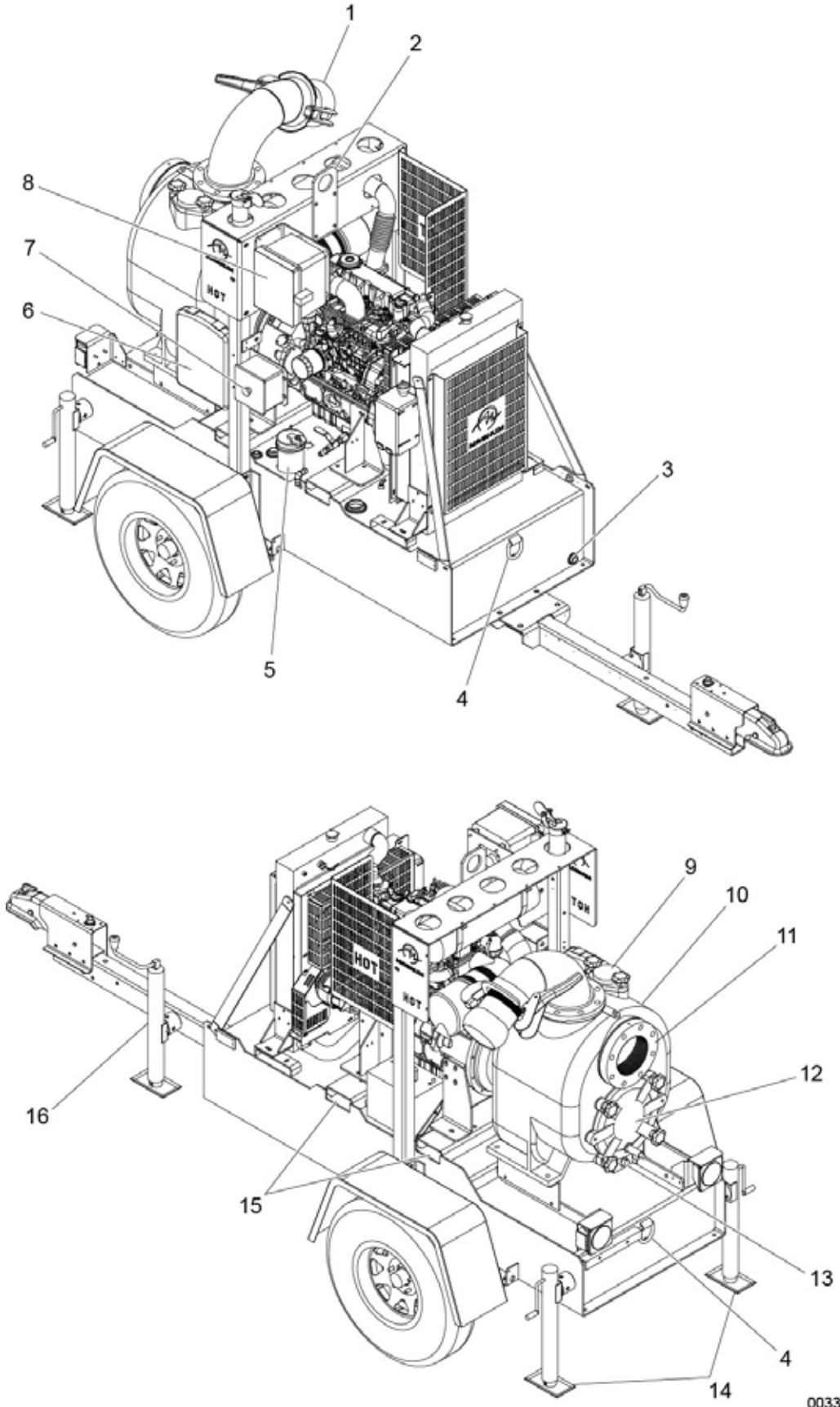

0033E

1. **PUMP OUTLET (DISCHARGE) PORT.** Opening for discharge of liquids from the pump. Fittings can be threaded or bolted to the pump flange.
2. **CENTRAL LIFT EYE.** Used for lifting the pump.
3. **FUEL TANK DRAIN.** Drain for fuel tank for cleaning and/or maintenance.
4. **TIE-DOWN RINGS.** Used to secure the pump for storage and/or transport.
5. **FUEL FILL PORT.** Lockable port for filling the fuel tank with clean diesel fuel.
6. **MANUAL HOLDER.** Storage for operator manuals.
7. **EMERGENCY STOP.** Activate the emergency stop switch by pushing the red button in until it locks down. Only use when the pump must be shut down immediately. For any other shut down, follow the procedure *“Stopping The Pump” on page 43.*
8. **CONTROL PANEL.** Controls and indicators for pump operation.
9. **PRIMING PORT.** Used to fill the pump volute with water.
10. **PUMP VOLUTE (HOUSING).** Cast-iron housing for pump mechanical components.
11. **PUMP INLET (SUCTION) PORT.** Opening for intake of liquids into the pump. Fittings can be threaded or bolted to the pump flange.
12. **PUMP CLEANOUT COVER.** Provides access to pump internals for cleaning and/or maintenance.
13. **DRAIN/SUCTION HOSE RELEASE VALVE.** Allows for complete draining of the pump volute for storage and/or maintenance. This valve can also be opened to relieve pressure on the rear suction hose to facilitate removal of the hose.
14. **REAR LEVELING JACKS.** Used to level the rear of the pump on rough or uneven ground.
15. **FORK LIFT POCKETS.** Used for lifting the pump.
16. **FRONT LEVELING JACK.** Used to level the pump on rough or uneven ground and to aid in attaching the pump to a tow vehicle.

Note: Use hoses and fittings that are specifically designed and sized for this type of equipment.

CONTROL PANEL

The CANplus® 750 (CP750™) control panel is a universal platform to monitor, control and automatically start/stop both electronically and mechanically governed diesel engines. The microprocessor-based, solid-state design uses high power semiconductors instead of electromechanical relays to ensure reliable high current switching. Graphical gauge pages or a single large analog gauge are displayed on the 4.25 in. (10.79 cm) diagonal Liquid Crystal Display (LCD). Virtually any SAE J1939 parameter reported by the Engine Control Unit (ECU) can be displayed, including Revolutions Per Minute (RPM), coolant temperature, oil pressure, engine hours, voltage and diagnostic codes. The trans-reflective, backlit display is clearly readable in both bright sunlight and total darkness and is housed in a rugged IP67-rated housing.

Current alarm conditions are displayed in plain language on pop-up messages and can be viewed in the alarm list. Various diagnostic screens allow detailed investigation of the CANbus data stream. By accessing the “Configuration” menu, users can customize displayed data to show metric or US units, display language and various other parameters such as the full-scale reading of gauges. Four bright Light Emitting Diodes (LEDs) below the display indicate Auto Standby, Preheat, Stop and Warning status.

Five buttons access a context dependent button bar when any button from 1 to 4 is pressed. The graphical menu structure uses icons to indicate the button’s current function. After five seconds of inactivity, the button bar disappears.

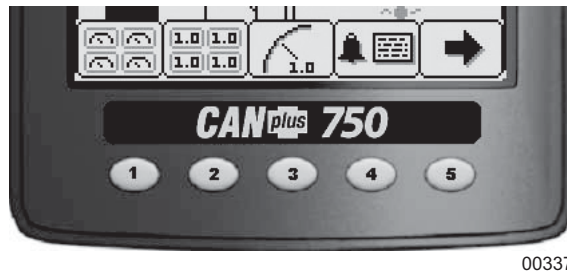

Button 1	Button 2	Button 3	Button 4	Button 5
<p>Analog Gauge Pages</p> <p>Press repeatedly to cycle through four pages of analog gauges (16 total).</p> <div style="display: flex; justify-content: space-around;"> <div style="text-align: center;"> </div> <div style="text-align: center;"> </div> </div> <div style="display: flex; justify-content: space-around;"> <div style="text-align: center;"> </div> <div style="text-align: center;"> </div> </div> <p style="text-align: right;">00332</p>	<p>Digital Gauge Pages</p> <p>Press repeatedly to cycle through four pages of digital gauges (16 total).</p> <div style="display: flex; justify-content: space-around;"> <div style="text-align: center;"> </div> <div style="text-align: center;"> </div> </div> <div style="display: flex; justify-content: space-around;"> <div style="text-align: center;"> </div> <div style="text-align: center;"> </div> </div> <p style="text-align: right;">00333</p>	<p>Single Analog Gauge</p> <p>Press repeatedly to cycle through available analog gauges.</p> <div style="text-align: center;"> </div> <p style="text-align: right;">00338</p>	<p>Active Alarm Page</p> <p>Displays active alarms with a plain language description.</p> <div style="text-align: center;"> </div> <p style="text-align: right;">00339</p>	<p>Gauge Adjust</p> <p>Configures the parameters displayed by gauge pages.</p> <div style="display: flex; justify-content: space-around;"> <div style="text-align: center;"> </div> <div style="text-align: center;"> </div> </div> <div style="display: flex; justify-content: space-around;"> <div style="text-align: center;"> </div> <div style="text-align: center;"> </div> </div> <p style="text-align: right;">00332</p> <p>(Quad Adjust must be enabled.)</p>

Note: Most problems with electronically controlled engines can be pinpointed via ECU diagnostic messages. Use the display or ECU diagnostic tool to view fault codes. Engine state information and diagnostic codes displayed by the CANplus display are provided via the CANbus.

AUTOMATIC OPERATION

The CP750™ panel features advanced automatic start/stop controls which can meet almost any requirement. Two

switch inputs and a transducer input support a number of control scenarios. Single switch mode allows reliable operation with a single switch. Dual switch operation allows greater hysteresis when needed.

The transducer input supports simple start/stop operation by level or pressure and maintenance modes with speed modification.

- Programmable high and low set points control start/stop operation.
- Level maintenance modes monitor the operating point and adjust the engine speed to match the targeted set point with configurable aggressiveness.
- Dual switch inputs can be combined with the transducer input for redundant safety to protect against transducer sensor clog or failure.

THROTTLE CONTROL

The standard ramp throttle uses a momentary rocker switch to adjust the integral throttle control. All throttle commands are sent directly to the engine using CANbus throttle control.

SERVICE TIMERS

The CP750™ display provides 16 service timers to alert the operator of needed maintenance. The time interval for each timer can be adjusted in 10 hour increments. A pop-up message is displayed after the display self test if a timer has expired, alerting the user that service is required. The message is displayed on each power up until the elapsed timer is disabled or reset.

CANPLUS MESSENGER TELEMETRY OPTION

The optional CANplus Messenger system provides a variety of features to protect and support the equipment investment. Remote monitoring can alert maintenance requirements, operational problems, improper operation and location with geo-fence alert. The web-browser interface allows monitoring an entire fleet of equipment in a central location. Contact Magnum Power Products LLC for more information.

CONTROL PANEL OPERATION

Turning the control system key to the “RUN” position energizes the ECU, all LEDs illuminate once and a startup screen is displayed while a self test is performed. If the display beeps for longer than one second, it indicates a self test fault. Users can attempt to rectify the fault by restoring factory defaults. Refer to “Configuration” menu for details. Contact Magnum Power Products LLC for assistance if the fault persists.

After the startup screen is cleared, the display shows readings on its virtual gauges. Initially the analog gauges are displayed but the display uses the last displayed screen on subsequent startups. Refer to “Preferred Screen Store” for details.

If the ECU is preheating when the key switch is turned to the “RUN” position, the Preheat LED is illuminated. Preheat time varies with atmospheric and engine conditions. After waiting for the Preheat LED to extinguish, the engine is cranked by turning and holding the key switch in the “START” position until the engine starts.

Note: The ECU will not preheat unless conditions warrant. If necessary, starting the engine may be attempted by turning the key to the “START” position without waiting for preheat to expire. The key switch is spring loaded to return automatically to the “RUN” position when released. The key switch includes an interlock to prevent the key from being turned to the “START” position while the engine is running. The key switch must be turned to the “OFF” position to reset the starter interlock before the switch can be turned to the “START” position again.

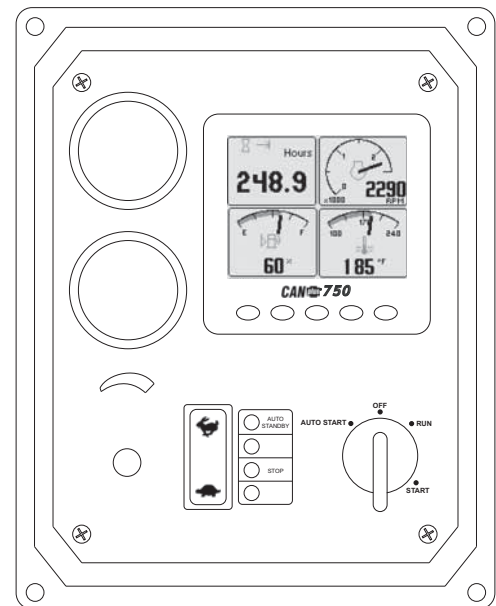

THROTTLE CONTROL

The type of throttle operators installed, along with the configured values of minimum requested RPM, idle RPM, intermediate RPM, run RPM and maximum requested RPM, determine throttle operation. The engine speed can be adjusted above run RPM and below idle RPM, but the requests can not fall below the set minimum requested RPM or above the set maximum requested RPM. The ECU determines how the engine responds to the throttle requests and will not allow the engine speed to fall below the ECU minimum or exceed the maximum RPM.

Note: To change the minimum requested RPM and maximum requested RPM settings, contact Magnum Power Products LLC.

RAMP THROTTLE (SPEED CONTROL SWITCH)

The standard ramp throttle uses a momentary rocker switch to adjust the requested engine speed. When first started, the requested engine speed is “Idle RPM”. Pressing and releasing the Rabbit 🐰 icon increases the speed requested by 25 RPM. Pressing and holding the rabbit icon causes the speed to accelerate to full speed in a few seconds. Similarly, pressing the Turtle 🐢 icon decreases the requested speed.

MECHANICALLY GOVERNED ENGINES

On mechanically governed engines, the CANplus I/O Board performs the ECU function by monitoring low oil pressure, high temperature and two additional engine faults. Three analog inputs broadcast the oil pressure, engine temperature and fuel level across the CANbus to the display and other J1939 devices. The engine speed can be controlled using the mechanical throttle. Refer to [“Starting The Pump” on page 40](#).

AUTOMATIC START/STOP OPERATION

The pump can be configured to start automatically by adding dry-contact closure float level switches. Ensure that the dry-contact closure float switch harness is connected to the port on the back of the control box. Contact the Magnum Power Products LLC Technical Service Department at 1-800-926-9768 for more information.

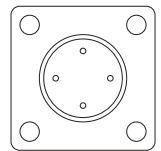

00343

Turning the control system key to the “AUTO START” position causes all LEDs to illuminate once the “AUTO STANDBY” indicator is illuminated and the startup screen is displayed while a self test is performed. After the startup screen is cleared, the display shows the transducer reading and switch status on the Transducer/Switch gauge. All other CANbus values will show **---** since the ECU is not energized at this time. After one minute, the display is powered down to reduce battery drain. The automatic start/stop system is still functioning as indicated by the Auto Standby LED.

For mechanically governed engines, the throttle must be adjusted manually. The unit will start and run at the manually set speed.

For electronically governed units, once the configured automatic start condition exists, the display powers up, the panel starts the engine and follows the throttle control profile configured (refer to diagram). The flexible throttle profile includes various speeds and times for a variety of scenarios.

When the configured stop conditions exist, the panel reduces the engine speed per the throttle profile and stops the engine. If the configured start conditions exist before the shutdown process is complete, the engine will return to the previous speed until the stop condition exists.

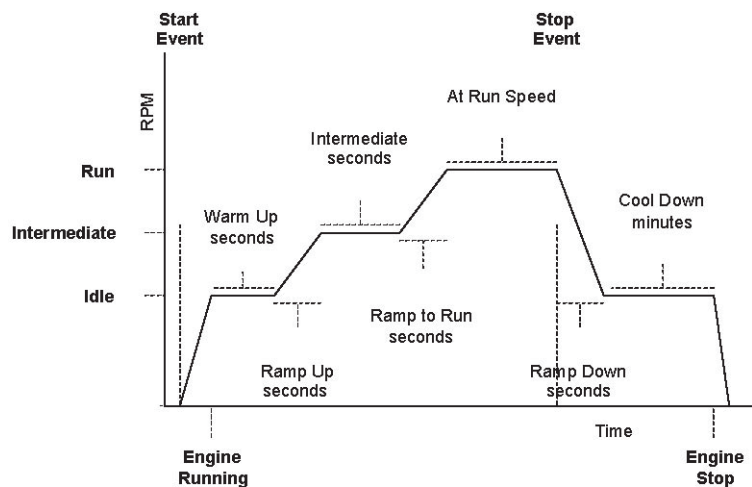

00344

⚠ WARNING

When the key is turned to the “AUTO START” position and a start condition exists, the panel will start *immediately*. Always configure parameters by turning the key to run. Do not configure the panel in the “AUTO START” position. Always use lock out/tag out procedures when servicing autostart equipment.

START AND STOP EVENTS

The start and stop events are determined by the combination of Start/Stop Mode and Function. Refer to the table below for:

START/STOP MODES

Sngl Switch Switch one controls automatic operation.

Dual Switch Both switch inputs control automatic operation.

Transducer The transducer input controls automatic operation.

Xducer & Sw The transducer input controls automatic operation with dual switch mode as the backup. The switch inputs override the transducer if actuated when the transducer is not calling for an automatic cycle.

START/STOP FUNCTIONS

Empty Uses the selected mode to *reduce* the level or pressure.

Fill Uses the selected mode to *increase* the level or pressure.

Maintain Out Uses the transducer to maintain the level or pressure at or *below* the target.

Maintain In Uses the transducer to maintain the level or pressure at or *above* the target.

Mode ▼	Function ►	Empty	Fill	Maintain Out	Maintain In
Sngl Switch	Start	SW1 Close	SW1 Open		
	Stop	SW1 Open	SW1 Close		
Dual Switch	Start	SW1 and SW2 Close	SW1 and SW2 Open		
	Stop	SW1 and SW2 Open	SW1 and SW2 Close		
Transducer	Start	Above High Set Point	Below Low Set Point	Above High Set Point	Below Low Set Point
	Stop	Below Low Set Point	Above High Set Point	Below Low Set Point	Above High Set Point
Xducer & Sw	Start	Above High Set Point or SW1 and SW2 Close	Below Low Set Point or SW1 and SW2 Open	Above High Set Point or SW1 and SW2 Close	Below Low Set Point or SW1 and SW2 Open
	Stop	Below Low Set Point or SW1 and SW2 Open	Above High Set Point or SW1 and SW2 Close	Above High Set Point or SW1 and SW2 Close	Below Low Set Point or SW1 and SW2 Open

Note: When the switch inputs are the source of the start event in Xducer & Sw mode, only the switches will stop the engine.

MAINTAIN FUNCTIONS

The Maintain In and Maintain Out functions adjust the engine speed to keep the transducer level at the Target Set Point. The Servo Gain adjusts how aggressively the throttle is adjusted while the Servo Delay controls how often

the throttle is adjusted.

Note: Maintain functions are only available in the Transducer or Xducer & Sw modes.

The direction of the throttle adjustment is dependent on the selected mode as shown in the table.

Transducer State	Maintain Out	Maintain In
Above Target	Increase Speed	Decrease Speed
Below Target	Decrease Speed	Increase Speed

DEAD BAND

In some situations, the transducer level may fluctuate around the Target Set Point. To limit throttle hunting using the maintain functions, a dead band can be programmed. This value prevents throttle adjustment while the level is within the band (refer to diagram). In essence, the speed is considered to be at the target whenever it is within the dead band.

Note: The dead band entered is the amount above and below the target point. For example, if the target is 5.0 ft (1.52 m) with a 0.1 ft (.03 m) dead band, the dead band is 4.9 to 5.1 ft (1.49 to 1.55 m).

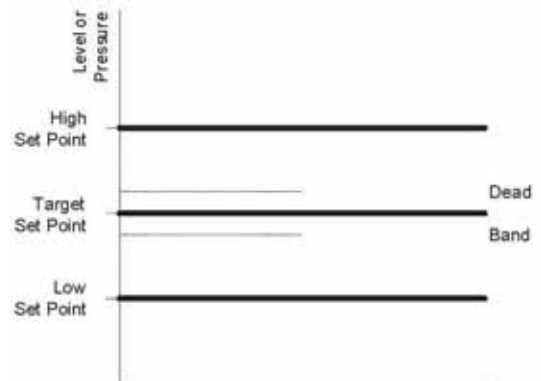

00345

CANPLUS DISPLAY

Soft buttons simplify the user interface by displaying a *button bar* above the buttons when any of the first four buttons (buttons 1 to 4, starting from the left) are pressed. Icons on the button bar change to represent the current function of each button. The button bar disappears after five seconds if no further buttons are pressed.

Note: Different software versions may have slightly different displays.

ANALOG GAUGE PAGES

Analog Gauge Pages provide four independent pages of analog gauges. To enable Analog Gauge Pages, press any of the first four buttons to show the top level button bar and then press button 1 . Alternate pages are selected by repeated pressing of button 1. The four standard gauge pages are shown below.

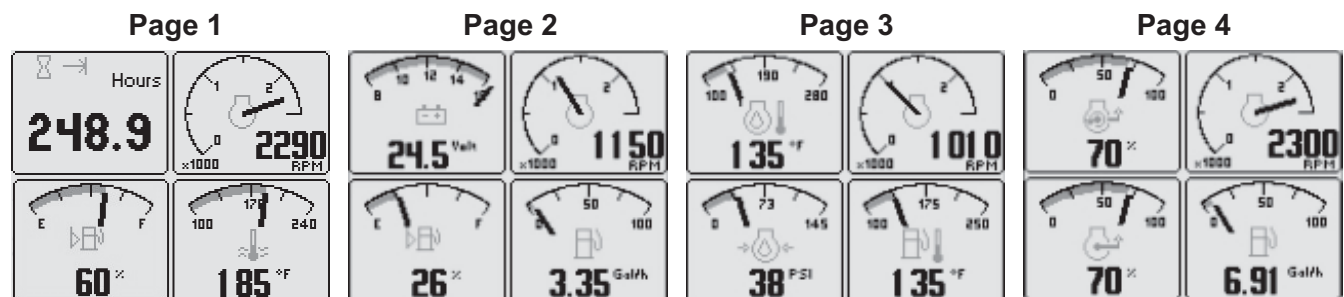





00331

Note: Engine Hours are displayed as a digital value even on Analog Gauge Pages. The default gauge pages represent 13 selections since the tachometer is repeated in the upper right quadrant of each page.

All 16 gauges may be configured by the user to create an application-specific view of CANbus data. Gauges on the current page can be changed via Adjust Mode, accessed by pressing button 5 when the button bar is visible. Gauges can be changed on any of the four pages by selecting the page to be changed and then entering Adjust Mode.

Note: “Quad Adjust” must be enabled to access the Adjust mode.

In Adjust Mode, a new button bar is displayed identifying the button functions. Button 1  corresponds to the upper left gauge, button 2  to the upper right gauge, button 3  to the bottom left gauge and button 4  to the bottom right gauge. Successive presses of the buttons selects a different parameter for the gauge. Adjust Mode is exited by pressing button 5  and storing the new configuration even when power is removed.

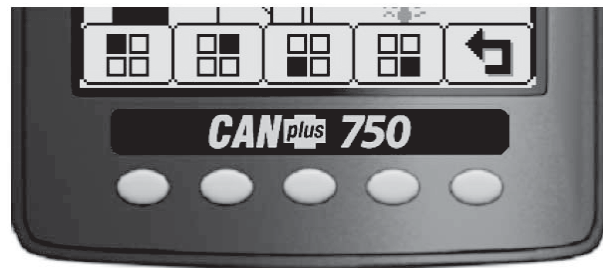

00342

Note: A gauge selection can only appear once per page. To move a gauge selection, the existing gauge location must be changed first. Gauge selections are limited to the data currently being received. Analog Gauge Pages can be configured in Demo Mode to select any supported parameter. Refer to Data Parameters Monitored for a complete list of available parameters.

Adjust Mode can be disabled in the “Configuration” menu (“Quad Adjust - Off”) to prevent accidental changes.

DIGITAL GAUGE PAGES

Digital Gauge Pages display the same data as the Analog Gauge Pages but in digital only format. To enable Digital Gauge Pages, press any of the first four buttons to show the top level button bar and then press button 2 . Alternate pages are selected by repeated pressing of button 2. The four standard Digital Gauge Pages are shown below.

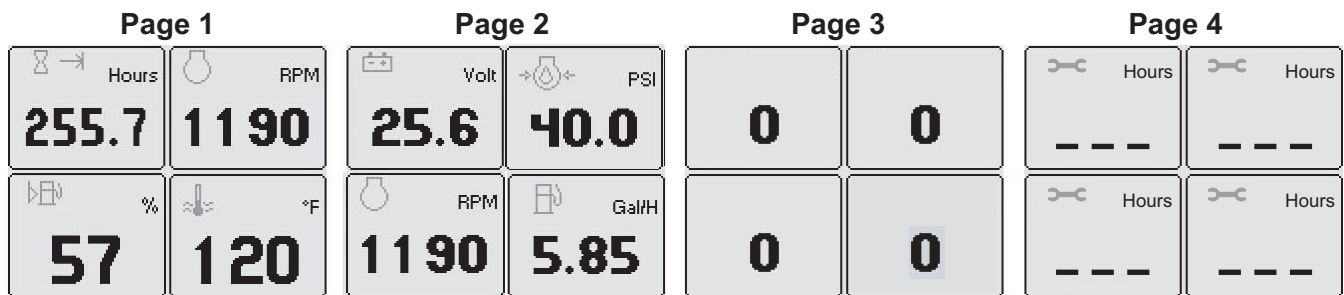

00346

Note: The 16 gauges are the same for Analog and Digital Gauge Pages. Adjustments in either Analog Gauge Pages or Digital Gauge Pages affect the same gauge in the other mode.

SINGLE ANALOG GAUGE

Single Analog Gauge uses the entire display for a single large analog gauge. This mode is enabled by pressing any of the first four buttons to show the top level button bar and then press button 3. The gauge displayed is selectable by repeatedly pressing button 3  while in the Single Analog Gauge mode while the menu bar is visible. The currently displayed gauge is stored when power is removed. Refer to Preferred Screen Store.

Note: Gauge selections are limited to the data currently being received. Refer to Data Parameters Monitored for a complete list of available parameters.

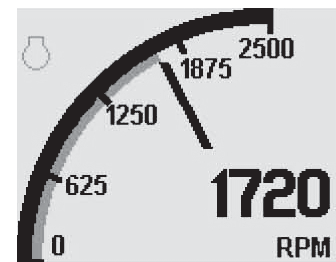

00347

ANALOG TRANSDUCER/SWITCH GAUGE

The Analog Transducer/Switch Gauge displays the transducer value and the switch input states. The left column represents the values as a bar graph with a digital value displayed below. The right column shows whether the switches are “open”, represented by the pointer being down, or “closed”, represented by the pointer being up.

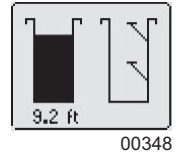

DIGITAL TRANSDUCER GAUGE

The Digital Transducer Gauge displays the transducer value as a digital only value. The switch state is not displayed on the Digital Transducer Gauge.



ACTIVE ALARMS

A flashing pop-up window is overlaid on the current screen when an active alarm is received. The pop-up includes a plain language description in addition to the standard SPN/FMI (Suspect Parameter Number/Failure Mode Indicator) pair defined by the SAE J1939 standard. Additionally, if enabled, the beeper sounds as an audible cue.

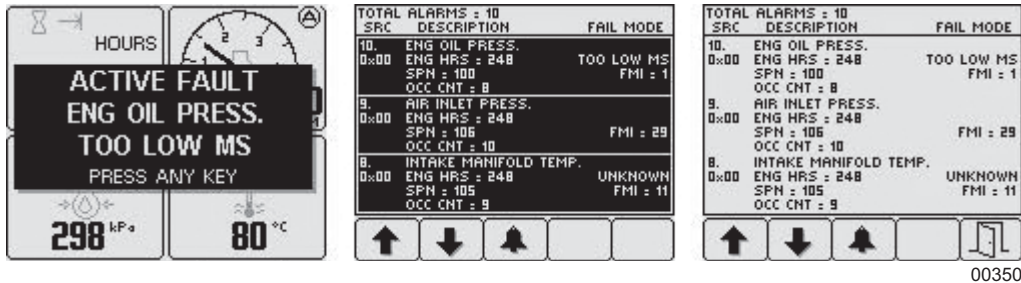

In the examples above are alarm list screens showing unacknowledged conditions and acknowledged alarms. After acknowledgement, the exit button becomes active.

Note: Standard J1939 abbreviations are used for alarms. MS = Most Severe, MOD= Moderately Severe, LS = Least Severe.

ALARM LIST

The Alarm List is accessed by pressing any button while an alarm pop-up is displayed or by pressing any of the first four buttons to show the button bar and then button 4 . Alarms not yet acknowledged are shown in grey on black while acknowledged alarms are shown in black on grey. The list also indicates when the alarm occurred if engine hours are available. The most recent alarm is displayed at the top of the list. The list can be scrolled using buttons 1 and 2 and alarms acknowledged by pressing button 3 . The Alarm List can be closed by pressing button 5 once the alarms are acknowledged.

An alarm indicator is displayed near the upper right corner of the display as long as alarms are active. The indicator and alarm messages in the list are automatically removed when the alarm is no longer received for a few seconds.

Note: Only active faults are displayed in the alarm list. Once a fault is corrected, it is automatically removed from the list. To view previously active faults, use the engine diagnostic tool.

CONFIGURATION

To adapt the CP750™ panel to the requirements of a particular application, a large number of parameters are configurable. The most commonly modified parameters can be accessed by invoking the “Configuration” menu of the display. Infrequently changed parameters and those parameters that typically need to be restricted, such as Maximum RPM, are accessible only through the CANplus Configurator. The CANplus Configurator is a Windows® PC program and a hardware adapter that allows total access to the parameters of the panel. For more information

about the CANplus Configurator, please contact Magnum Power Products LLC.

CONFIGURATION MENU

This “Configuration” menu allows the user to set various operating parameters such as US or Metric units, scale limits for tachometer and service timers. The “Configuration” menu is entered by pressing and holding button 5 (the right hand button) in any mode for at least three seconds. If PIN (Personal Identification Number or ‘password’) entry is enabled the correct PIN must be entered to access the “Configuration” menu. The top level “Configuration” menu is displayed as shown. Buttons 1 (↑) and 2 (↓) allow you to choose from “Display”, “System”, “Autostart”, “Settings”, “Telemetry” or “Db Viewer”. Pressing button 4 (→) selects the chosen menu item indicated by bold text and the selection arrow →. Each item is described in detail on the following pages. Settings are automatically stored when exiting the current menu even when power is removed.

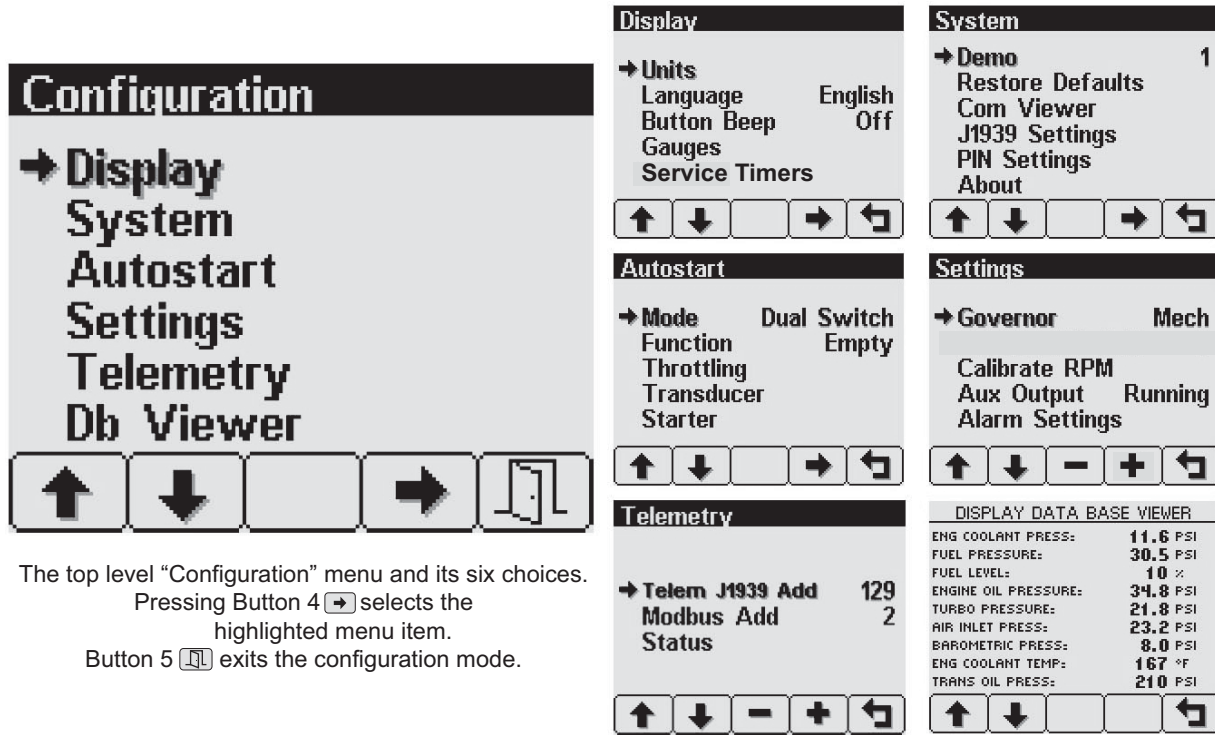

Note: Most configuration changes take affect immediately. Some, such as Idle RPM, take effect on the next power up.

DISPLAY MENU

The “Display” menu allows the user to configure items affecting how information is displayed.

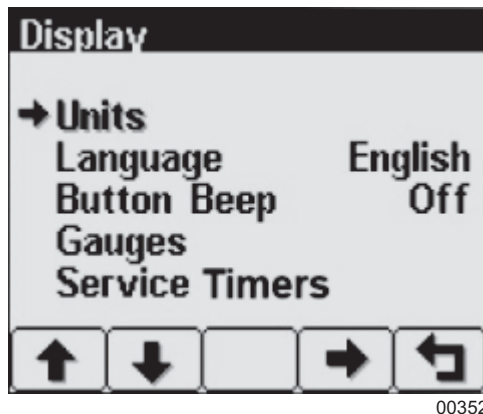

UNITS MENU

This menu allows the user to set the units used for speed, distance, pressure, volume and temperature independently. Button 4  cycles through the available values for the selected item.

Speed	MPH (miles per hour); km/h (kilometers per hour); Knts (knots)
Distance	Miles; km (kilometers); NM (nautical miles)
Pressure	PSI (pounds per square inch); bar (barometric units); kPa (kilopascals)
Volume	Gal (US gallons); IGal (Imperial gallons); Liters
Temperature	°F (Fahrenheit); °C (Celsius).

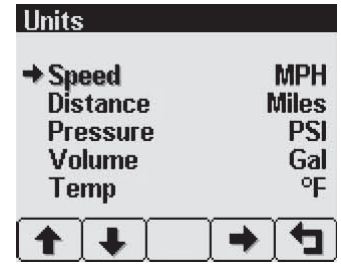

LANGUAGE MENU



This menu allows the user to choose between English, Swedish, French, German, Spanish, Italian, Dutch and Portuguese. The currently selected value is indicated by the check mark . Button 4  selects the highlighted value.

BUTTON BEEP

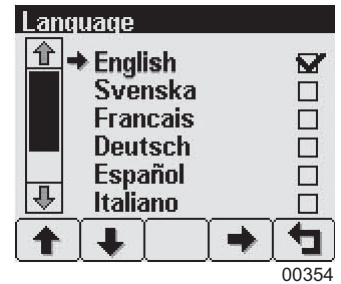
The soft buttons emit an audible beep when this item is “On”. Button beep is disabled by setting this item to “Off”. The audible beep still sounds when an alarm occurs. Button 4  cycles between “On” and “Off”.



GAUGES MENU

This menu allows the user to configure aspects of the gauges displayed. Button 3  selects the previous value while button 4  selects the next value of the highlighted item.

MAX RPM

Sets the full scale RPM indicated by the tachometer gauge.

RPM 2500, 3000, 3500, 4000, 4500, 5000, 6000, 7000, 8000 or 9000



MAX SPEED

Sets the full scale speed indicated by the speedometer gauge.

MPH 15, 20, 25, 30, 35, 40, 45, 50, 55, 60, 70, 75, 80, 85, 95 or 100

km/h 20, 30, 40, 50, 60, 70, 80, 90, 100, 110, 120, 130, 140, 150 or 160

QUAD ADJUST

Allows the user to disable Adjust mode of the Analog and Digital Gauge Pages. Button 3  disables while button 4  enables Quad Adjust. Disabling Adjust mode locks the current gauge configuration and prevents the operator from accidentally changing the gauge configuration.

VOLTMETER



Leave setting at the 12V factory default. (24V is not available on this unit.)

SERVICE TIMERS

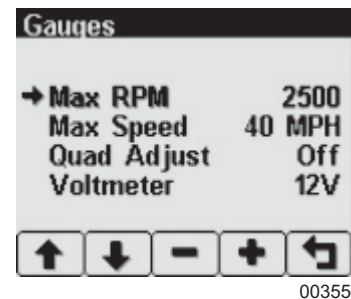
Sets the 16 service intervals in hours and resets the service timer. Setting the service interval to 0 disables the timer and the word “Off” is displayed.



Pressing button 4  allows adjusting the selected service timer.

Button 1  decreases the service interval time while button 2  increases the service interval time in 10 hour increments. Holding button 3  for approximately three seconds resets "Next Service In" to the current service interval. The service timer descriptions can be changed using the CANplus Configurator.

Note: It is not possible to set the service timers if engine hours are not being received by the display.

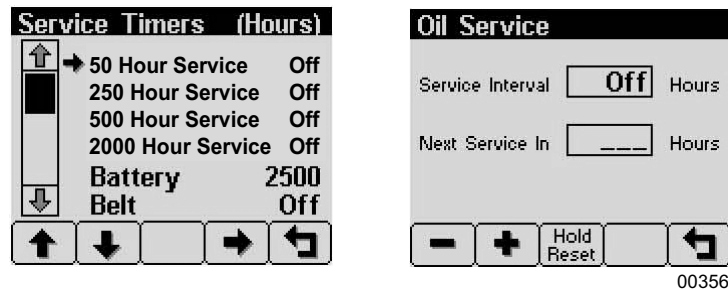

SYSTEM MENU

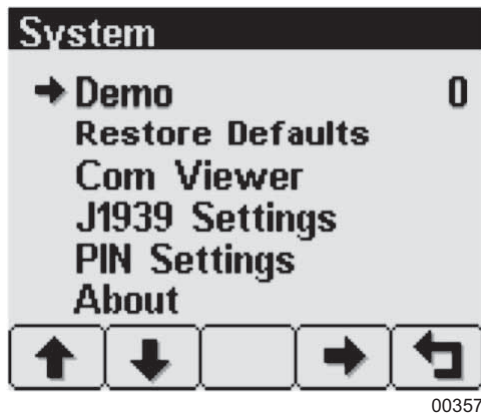

The "System" menu allows the user to configure items affecting how the system functions. Button 4  cycles through the available values for the selected item.



Demo

The display supports several demo modes to operate with simulated data. Mode 1 simulates speed data and engine parameters. Mode 2 only simulates engine parameters. Mode 3 simulates speed data, engine parameters and alarms. Mode 0 disables "Demo" mode. "Demo" is automatically set to 0 (Off) if live data is received.

RESTORE DEFAULTS

This allows resetting of all configuration information to default US  or Metric  units. Additionally, the display is reset to the initial configuration.

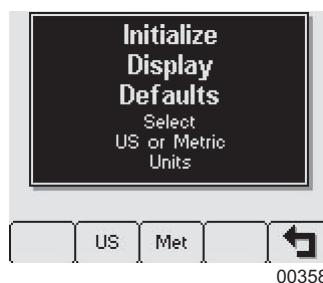

The default settings are:

Setting	US	Metric
Language	English	
Button Beep	On	
Service Timers	Off	
Display Mode	Analog Gauges	
Gauge Pages	Defaults	
Quad Adjust	On	
Demo Mode	0 (Off)	
Engine Source	0	
Display CAN Address	40	
Alarm Filter	Glb	
SPN Version	1	
Speed Source	Auto	
PIN Entry	Off	
PIN	1111	
Max Gauge RPM	2500	
Max Gauge Speed	40 MPH	60 km/h
Speed Units	MPH	km/h
Distance Units	Miles	km
Pressure Units	PSI	kPa
Volume Units	Gal	l
Temperature Units	°F	°C

COM VIEWER

Displays CANbus data received and engine configuration transmitted by the ECU.

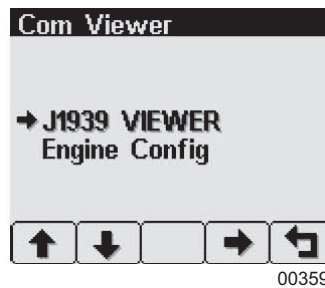

J1939 VIEWER

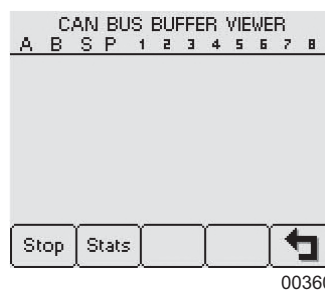

This screen provides a hexadecimal dump of the messages received on the CANbus. This viewer displays the raw data. To see the decoded data, use the “Db Viewer”.

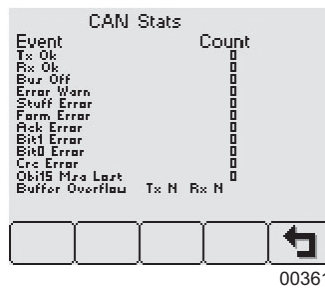

Button 1  freezes the display while button 2  shows the CANbus data statistics screen.



ENGINE CONFIG

This screen displays the engine configuration information received from the ECU. Button 2  selects the next page of engine configuration while button 1  selects the previous page.

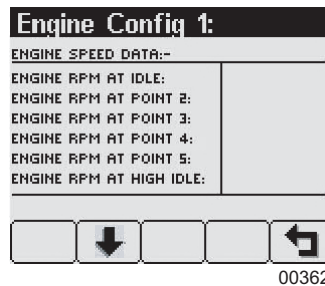

J1939 SETTINGS

This screen allows adjustments specific to the J1939 data link.

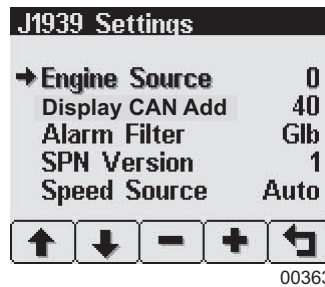

ENGINE SOURCE

Selects which source the display listens to for gauge data. Every device on a J1939 network has a unique address (in the range 0-254) to which the display can choose to listen. The display listens to a single data source; usually the ECU at address 0.

Note: Incorrectly configuring the "Engine Source" address will result in no data available for display.

DISPLAY CAN ADD

As mentioned previously, every device has a unique address and the display is no different. The default display address is 40, the recommended address for single engine setups.

Note: Incorrectly configuring the "Display CAN Address" can result in data collisions on the CANbus.

ALARM FILTER

This setting specifies whether the display will display alarms from all sources (*Glb* or global) or only the source address specified in the "Engine Source" setting (*Src* or source).

SPN VERSION

Selects the default SPN (Suspect Parameter Number) conversion method version to 1, 2 or 3. Version 4 is automatically detected, but older engines that use conversion method 1, 2 or 3 requires setting this parameter correctly.

Note: Consult your engine supplier to establish the appropriate SPN conversion method version. Selecting the wrong version will cause alarm data to be displayed incorrectly.

SPEED SOURCE

There are three sources of speed data the display can decode. The settings for this parameter are "Auto", "NMEA", "Wheel", "Nav" and "Off". "Auto" prioritizes the sources (highest to lowest); "NMEA", "Wheel" (PGN 65265), "Nav" (PGN 65272). The selection can be forced to one of the available sources by selecting it explicitly. Selecting "Off" stops the display listening to any source of speed data.





PIN SETTINGS

By default, PIN (Personal Identification Number) security is disabled. The user is prompted to enter a PIN every time the "Configuration" menu is accessed after this feature is enabled.

PIN ENTRY

This allows turning "PIN Entry" on or off. To enable the "PIN Entry" feature, select "PIN Settings" and press button 4 to enable. As a security feature, a default pin number must be entered. Contact Magnum Power Products LLC to obtain the number. Once the PIN has been entered, the feature is enabled. "PIN Entry" is disabled by setting "PIN Entry" to "Off".

The digits of the PIN are entered by using the buttons corresponding to the digits of the PIN.

Button 1  adjusts the first digit of the PIN. Button 2  adjusts the second digit, button 3  the third digit and button 4  the fourth digit. The PIN is entered using button 5 .

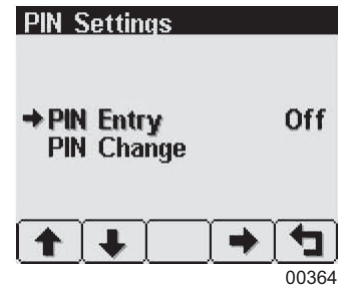

00364

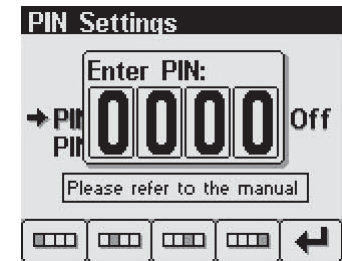

00365

PIN CHANGE

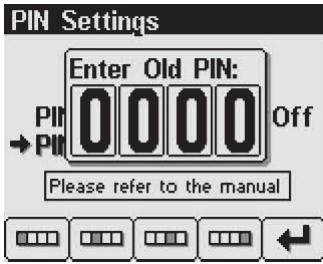

This allows changing the PIN. The user is prompted for the current PIN.

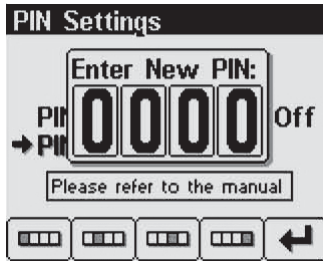

The user is prompted for the new PIN.

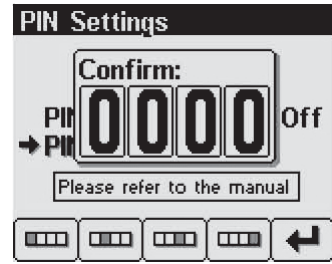

The new PIN must be confirmed before the PIN is changed.

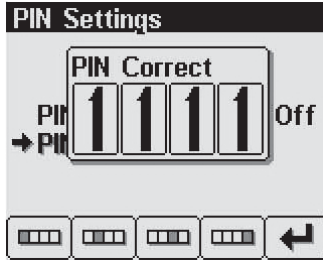

If the new PINs match, a confirmation screen is displayed.

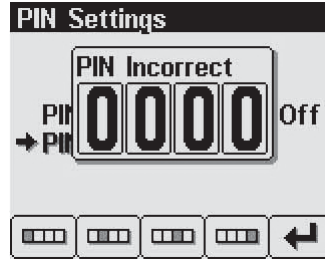

If the two PINs do not match, an error message is displayed and the PIN is unchanged.

00366

⚠ WARNING

If the PIN is changed from the default and the new PIN is lost, the configuration mode will not be accessible. Clearing the PIN requires returning the display to LOFA Industries Inc. for service. Contact LOFA Industries Inc. at 770-569-9828.

ABOUT

Displays the following product information:

JOB	N/A
CONFIG	Magnum programmed controller part number
ADAPTER	Last adapter serial number used to program the controller
VERS	Software version number
PRODUCT	Controller model name
RUN TIME	Hours the unit has been run



00367

Note: This screen can not be exited until the checksum calculation is complete. Checksum calculation takes approximately 10 seconds and is complete when the checksum value changes from "Calculating"... to a hexadecimal value such as 0x704E – OK.

AUTOSTART MENU

This submenu allows the user to configure automatic start/stop operation. Refer to [“Automatic Start/Stop Operation” on page 16](#) for more information.

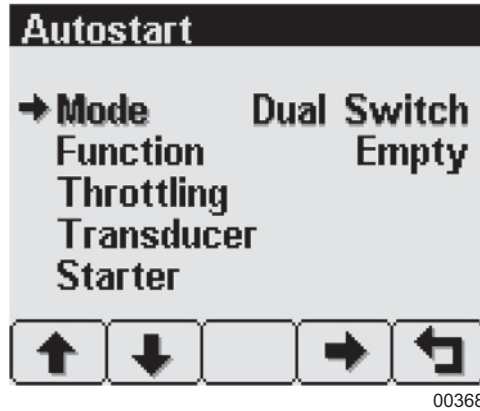

MODE

This menu selects the basic automatic start/stop operation mode. Button 4 cycles between *Single Switch*, *Dual Switch*, *Transducer* or *Xducer & Sw.*

FUNCTION

This menu selects the automatic start/stop function. Button 4 cycles between *Empty*, *Fill*, *Maintain Out* and *Maintain In*.

THROTTLING MENU

The throttling menu allows the user to configure throttle control. It also allows programming the automatic start/stop throttle profiles as shown in the diagram on [page 16](#).

IDLE RPM

Selects the RPM the control system will request for idle speed. Idle can be set to compensate for parasitic loads such as hydraulic pumps or compressors. “Idle RPM” is the low speed setting of the optional two state or three state throttle switches.

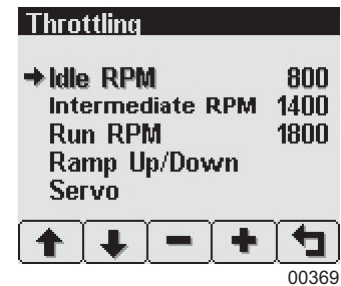

Note: The minimum engine speed is set by the ECU. Requesting a lower speed causes the engine to run at the ECU minimum speed. RPM limits are programmed into the panel to limit the requested speed. Contact Magnum Power Products LLC for information on changing the panel minimum requested RPM and maximum requested RPM.

INTERMEDIATE RPM

Selects the RPM the control system will request for intermediate speed. The intermediate speed can be used to prime pump or charge lines during automatic start/stop operation. Intermediate RPM is the middle setting of optional three state throttle switches.

Note: Setting the Intermediate RPM to the same speed as Idle RPM and Ramp to Run to 0 seconds is effectively two speed automatic operation.

RUN RPM

Selects the RPM the control system will request for run speed. The run speed is the normal operating speed during automatic start/stop operation. “Run RPM” is the high speed setting of the optional two state or three state throttle

switches.

RAMP UP/DOWN

This submenu configures the speed profile for automatic start/stop operation.

Warm Up s

Selects the number of seconds to operate at idle speed before beginning the ramp to intermediate speed. The warm-up time begins when the starter is disengaged.

Ramp Up s

Selects the number of seconds to ramp from idle speed to intermediate speed after warm-up.

Intermediate s

Selects the number of seconds to operate at intermediate speed before ramping to run speed.

Ramp to Run s

Selects the number of seconds to ramp from intermediate speed to run speed after intermediate warm-up.

Ramp Down s

Selects the number of seconds to ramp from current speed to idle speed. The ramp down time begins when the automatic start/stop system detects a stop event.

Cool Down m

Selects the number of minutes to operate at idle speed after ramp down time. At the end of the cool down period, the engine will be stopped.

SERVO

Configures the servo profile for autostart maintain modes.

Gain

Controls the aggressiveness of the maintain servo modes.

Delay 10mS

Controls how quickly the maintain servo mode responds to changes in level.

TRANSDUCER

This submenu configures the transducer type and set points.

Type

Selects between Level and Pressure CANplus Configurator.

Range

Selects appropriate range for the transducer type.

High Set Point

For Empty and Maintain Out modes, sets the level that begins an autostart cycle. For Fill and Maintain In modes, sets the level that ends the cycle.

Maintain Point

Sets the target point for maintain modes.

Ramp Up/Down	
→ Warm Up s	0
Ramp Up s	0
Intermediate s	0
Ramp To Run s	0
Ramp Down s	0
Cool Down min	0
↑	↓
-	+
↶	

00370

Servo	
→ Gain	5
Delay 10mS	1
↑	↓
-	+
↶	

00371

Transducer	
→ Type	Level
Range ft(Psi)	23.1(10)
High Set Point ft	0.0
Maintain Point ft	0.0
Low Set Point ft	0.0
Dead Band ft	0.0
↑	↓
-	+
↶	

00372

Low Set Point

For Empty and Maintain Out modes, sets the level that ends an autostart cycle. For Fill and Maintain In modes, sets the level that begins a cycle.

Dead Band

Sets the amount of change from the target point required to alter the engine speed.

STARTER

This submenu configures starter control options for autostart.

Restart Attempts

Selects the number of times to attempt restart.

Restart Delay Sec

Selects the number of seconds to wait before attempting a restart.

Start on Sec

Selects the maximum number of seconds the starter can be engaged.



00373

SETTINGS MENU

This submenu allows the user to configure CANplus hardware.

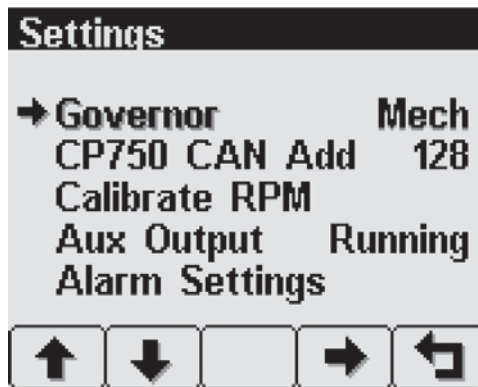

00374

GOVERNOR

Selects between Elect (electronically governed) and Mech (mechanically governed) engines modes. For mechanically governed engines the CANplus I/O Board functions as an ECU, broadcasting engine parameters such as oil pressure and temperature on the CANbus.

Note: Switching governor modes requires cycling power before calibrating the RPM. The CANplus Configurator must be used to configure mechanical engine parameters.

CP750 CAN ADD

Selects the address used by the display to communicate with the CANplus I/O Board. The default I/O Board address is 128.

Note: Engine data is always transmitted using address 0 in mechanically governed mode.

▲ WARNING





Incorrectly configuring the CP750 CAN Address prevents the display from receiving I/O Board data for the display menus and can result in data collisions on the CANbus.

CALIBRATE RPM

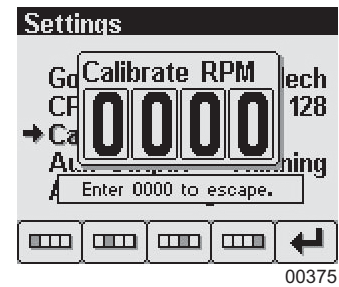
Calibrates the tachometer input for mechanically governed engines to allow the CANplus I/O Board to measure the engine speed. This signal may be provided by an alternator frequency tap, proximity switch. An optional amplifier/divider can be added for use with a magnetic pickup.

Note: Calibrate RPM is only available on mechanically governed engines. The RPM must be calibrated for automatic start/stop operation to function.



Crank the engine and measure the engine RPM with a handheld tachometer. Select Calibrate RPM and enter the digits of the measured RPM using the buttons corresponding to the digits of the RPM. Button 1  adjusts the first digit of the RPM. Button 2  adjusts the second digit, button 3  the third digit, and button 4  the fourth digit. The RPM is entered using button 5 .

When the calibration is complete, the LEDs will begin a blinking sequence. The power must be cycled to continue configuration or operation.

AUX OUTPUT

Selects the Aux Output function and provides a 1 amp low side switch.

- Running** The output is active when the engine RPM exceeds 500 RPM.
- AS Armed** The output is active when the key switch is in the Autostart position and the engine has not stopped due to a fault.
- At Speed** The output is active when the engine is at or above the operating RPM.
- Prestart** The output is prestart alarm activated 10 seconds before the engine automatically starts.

Note: The Aux Output is available on a connector in the I/O Board only. Changing the prestart alarm time requires using the LOFA Configurator.

ALARM SETTINGS

Configures the set points for the transducer alarm messages. The alarm is transmitted as SPN 1083 with FMI 1 for a low alarm and FMI 0 for a high alarm.

Low Level ft
Sets the transducer low level alarm set point.

High Level ft
Sets the transducer high level alarm set point.

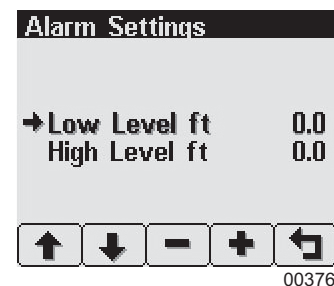

TELEMETRY MENU

This menu allows configuring the optional telemetry system.

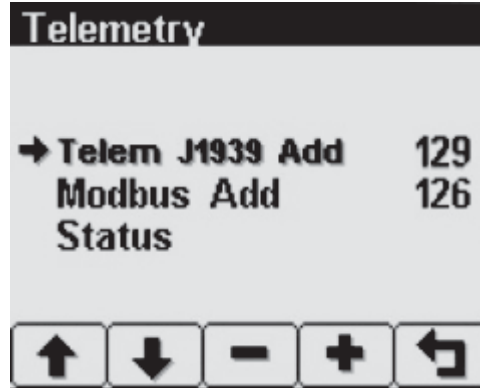

00377

TELEM J1939 ADDRESS

Defines the address the telemetry module is using for CANbus communications.

Note: The display will be unable to communicate with the telemetry module if this address is incorrect.

MODBUS ADDRESS

Selects the Modbus slave address the telemetry module will use for Modbus communications.

STATUS

Displays telemetry and modem status information retrieved from the telemetry module:

MODEM TYPE	Identifies the modem type
CELL REG	Identifies cell modem registration
CELL STATE	Indicates cell state and signal strength
GPS	Indicates GPS status
RTC	Indicates number of days since real time clock cellular update
MODBUS SSLT	Indicates Modbus slave status
HDW STATUS	Indicates various hardware status items
SOFTWARE VER	Indicates the version of software in the Messenger

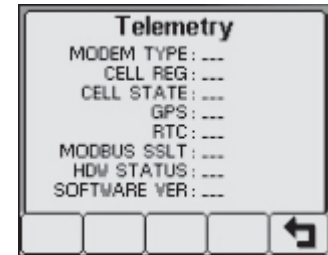

00378



DB VIEWER

The “Database Viewer” displays and decodes all data monitored by the display. This diagnostic tool allows viewing data not normally displayed.

DISPLAY DATA BASE VIEWER	
ENG COOLANT PRESS:	16.9 PSI
FUEL PRESSURE:	30.5 PSI
FUEL LEVEL:	65 %
ENGINE OIL PRESSURE:	51 PSI
TURBO PRESSURE:	29.8 PSI
AIR INLET PRESS:	28.5 PSI
BAROMETRIC PRESS:	15 PSI
ENG COOLANT TEMP:	184 °F
TRANS OIL PRESS:	237 PSI



00379

The list can be scrolled using buttons 1  and 2  and closed by pressing button 5 .

Note: The “Database Viewer” is always in English regardless of language selected.

PREFERRED SCREEN STORE

The display automatically stores the current screen as the preferred screen after a delay of approximately 15 seconds. The display will use the last stored screen on the next power up.

Note: Selecting “Restore Defaults” restores the Analog Gauge Pages and default gauges.

POP-UP MESSAGES AND ALERTS

SERVICE REQUIRED

Users can set up to 16 service timers in hours in the “Configuration” menu. The “Service Required” pop-up is displayed at power up when one or more service timers has expired. Pressing any button removes the pop-up. If no button is pressed, the pop-up closes in approximately five seconds.

POP-UP WARNINGS OF SERVICE REQUIRED AND DATA COMMUNICATIONS FAILURE

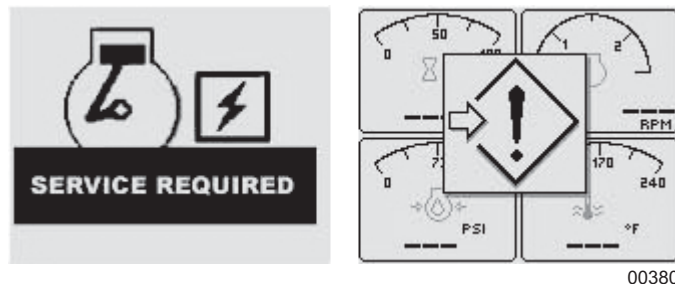

00380

DATA COMMUNICATIONS FAILURE

The “Data Communications Failure” pop-up icon flashes if the display does not detect data. The warning disappears and normal operation resumes once data is detected.



Note: Incorrectly configuring the “Engine Source” address will result in no data available for display.

DATA NOT AVAILABLE

Gauges and the “Db Viewer” will display  if the desired data is not available. The display value returns to normal

when parameter data is received.

ADJUSTING LIGHTING AND CONTRAST

Pressing button 5 (the right-hand button) when there is no menu bar opens the lighting and contrast menu bar. The display has a number of backlighting levels, allowing the display to be read in the dark. The level is adjusted by pressing button 1 to decrease, or button 2 to increase  illumination. Contrast is adjusted in the same manner using buttons 3 and 4 .

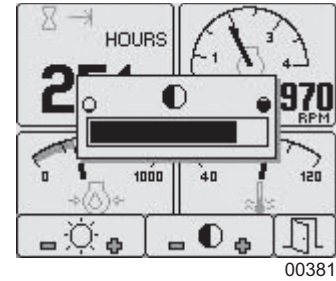

Note: The display adjusts the contrast with ambient temperature. Manual contrast adjustments are only necessary with extreme climate change.

The menu is exited by pressing button 5 . The lighting and contrast settings are retained after the unit is powered off.

Note: If the contrast has been adjusted poorly, the factory setting is restored by pressing buttons 1 thru 4 simultaneously. This action does not change other user-configured settings.

INDICATORS

AUTO STANDBY LED (GREEN)

A solidly illuminated “Auto Standby” LED indicates the keyswitch is in the “AUTO START” position and the system is ready to start.



PREHEAT LED (AMBER)

A solidly illuminated Preheat LED indicates the engine is preheating. When the LED extinguishes, the preheat period is complete and the engine may be cranked.

Note: The CANplus display only reports when the ECU is requesting preheat. Cold starting aids may not be installed in all engine configurations.



ENGINE STOP LED (RED)

A solidly illuminated Engine Stop LED indicates the ECU has stopped the engine due to a fault.

Note: ECU programming determines the response to warnings and failures. Typically the ECU can be programmed to shut down, derate, or run to failure. The CANplus display only displays ECU reported conditions.



























WARNING LED (AMBER)































A solidly illuminated Warning LED indicates a warning reported by the ECU.







Note: The Warning LED is not used in Mechanical Governor mode.

DATA PARAMETERS MONITORED

This table lists the engine and transmission parameters that are monitored via the CANbus. The parameters can be displayed by the user-configurable gauge pages or the single analog gauge. DB is an abbreviation for the internal database which stores all data transmitted from the engine/transmission. The complete database can be accessed on the display via the “Db Viewer” in the “Configuration” menu.

Icon	Parameter	Gauge Pages	Single Gauge	Database
	Electrical Potential	●	●	●
	Battery Voltage, Switched	●	●	●
	Net Battery Current	●		●
	Alternator Voltage	●	●	●
	Alternator Current	●	●	●
Fuel (L, Gal, lGal) or (L/h, Gal/h lGal/h) or (km/L, MPG or IMPG)				
	Fuel Level	●	●	●
	Fuel Rate	●	●	●
	Fuel Temperature	●	●	●
	Instantaneous Fuel Economy	●		●
	Trip Fuel Economy	●		●
	Trip Fuel	●		●
	Trip Fuel Rate	●		●
	Total Fuel Used			●
	Fuel Leakage 1			●
	Fuel Leakage 2			●
Distance (km, Miles or Nmiles)				
	Distance Remaining	●		●
	Trip Distance	●		●
	Total Vehicle Distance	●		●
Pressure (kPa, PSI or bar)				
	Fuel Pressure	●		●
	Barometer Pressure	●		●
	Auxiliary Pressure 1	●		●
	Turbo Pressure	●	●	●
	Air Inlet Pressure	●		●
	Air Filter Differential Pressure	●		●
	Injector Metering Rail 1 Pressure	●		●
	Injector Metering Rail 2 Pressure	●		●
	Engine Coolant Pressure	●		●

Icon	Parameter	Gauge Pages	Single Gauge	Database
	Engine Oil Pressure	●	●	●
	Transmission Oil Pressure	●	●	●
	Clutch Pressure	●		●
	Air Start Pressure	●		●
	Injector Control Pressure	●	●	●
Temperature (°C, °F)				
	Engine Coolant Temperature	●	●	●
	Engine Intercooler Temperature	●		●
	Engine Oil Temperature	●	●	●
	Transmission Oil Temperature	●	●	●
	Turbo Oil Temperature	●		●
	Intake Manifold Temperature	●	●	●
	Air Inlet Temperature	●	●	●
	Exhaust Temperature	●	●	●
	Auxiliary Temperature 1	●	●	●
	Engine ECU Temperature			●
	Exhaust Gas Port 1 Temperature	●		●
	Exhaust Gas Port 2 Temperature	●		●
	Turbo Inlet Temperature	●		●
Percentage (%)				
	Acceleration Position	●		●
	Engine Oil Level	●	●	●
	Coolant Level	●	●	●
	Fan Speed	●		●
	Drivers Demand Percent Torque	●		●
	Actual Engine Percent Torque	●	●	●
	Percent Load at RPM	●	●	●
Speed (RPM, km/h, MPH or KTS)				
	Input Shaft Speed	●		●
	Output Shaft Speed	●		●
	Engine Speed	●	●	●
	Turbo 1 Speed	●		●
	Engine Desired Operating Speed	●		●
	Fan Speed	●		●

Icon	Parameter	Gauge Pages	Single Gauge	Database
	Vehicle Speed	●	●	●
Time (h)				
	Total Engine Hours	●		●
	Trip Engine Hours	●		●
	Service Hours			●
Miscellaneous				
	Torque Converter Lock-Up Engaged			●
	Transducer	●	●	●
	Current Gear	●		●
	Selected Gear	●		●
	CANTX Disable			●
	CANplus I/O			●

PUMP PRE-USE CHECKPOINTS

Before using the pump, be sure to check the following:

- Place the pump as close as possible to the liquid being pumped, keeping the number of hose sections and couplings to a minimum. The pump should be the highest point between the intake and outlet section of the suction hoses.
- Make sure the ground is firm and as level as possible. Block the wheels on the trailer to keep it from moving.
- Check the pump discharge area; make sure discharge will not erode the material under the pump or damage any nearby structures.
- Make sure all hose couplings are of the same size and type.
- All hoses/piping should be supported, braced and lined up square before connection to the pump flanges. A flexible fitting is recommended on both suction and discharge to eliminate misalignment loads or stresses being transmitted to the pump.

Note: Flexible pipe couplings must be restrained so as not to transmit any strain to the pump flanges when expanding or contracting under pressure. Unrestrained expansion fittings can transmit enormous forces to the pump flanges.

⚠ WARNING

The pump is designed to handle water and/or other liquids containing some slurries and other entrained solids up to a certain diameter (Refer to [“Specifications” on page 11](#) for the correct diameter). It **MUST NOT** be used to pump volatile, corrosive or flammable materials that can damage the pump, cause pump failure or result in explosion. Serious personal injury could result.

PUMP SET UP

1. Disconnect the pump from the tow vehicle by turning the tongue jack clockwise to raise the tongue from the hitch. Disconnect all safety chains, surge brake cables and the trailer wiring harness. Block the wheels to prevent the unit from rolling.
2. Lower the rear leveling jacks from the travel position. Turn the jack handles clockwise until the leveling feet are in firm contact with the ground. Adjust the jacks until the pump is as level as possible.
3. Attach fittings to both the intake and outlet openings of the pump, making sure they match the fittings on the hoses. Make sure a gasket/seal is in place between the pump volute and the flange on the fitting being attached. Tighten all hardware completely to ensure an airtight seal. Threaded fittings require the use of pipe thread sealant.

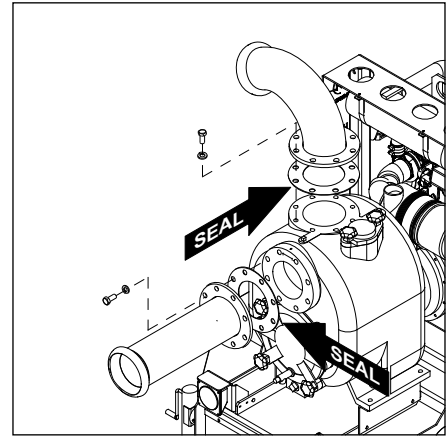

00428

4. Attach a rigid hose to the intake (suction) side of the pump. For best performance, the suction hose/piping should be at least as large as the pump flange, never smaller. The pump should be at the highest point of the hose/piping. All suction piping and fittings should be checked for any foreign material (rocks, bolts, wire, etc.) and also any sharp burrs that could disrupt the flow. Make sure the O-ring seal is present in the fitting on the pump before attaching the fitting. **Note:** Lubricate the O-ring seal with grease to ensure an airtight seal.

▲ CAUTION

The suction and discharge pipe/hose material should be compatible with the liquid being pumped. If a hose is used on the suction line, it should be of the reinforced type to prevent collapse under suction lift.

▲ DANGER

IF A MANUAL SHUTOFF VALVE IS INSTALLED IN THE DISCHARGE LINE, IT MUST NOT BE LEFT CLOSED DURING OPERATION. A CLOSED MANUAL SHUTOFF VALVE WILL CAUSE OVERHEATING AND POSSIBLE EXPLOSIVE RUPTURE OF THE PUMP CASING. PERSONNEL COULD BE SERIOUSLY INJURED.

5. Attach a rigid intake screen or strainer to the end of the suction hose before placing it in the liquid. This will prevent large items or excessive trash from entering the pump housing. The screen must have enough openings to equal 28 sq. in. (181 sq. cm) or more (6 in. pump). The screen should be rigid enough to prevent collapse when flow is reduced due to clogging.
6. Place the intake hose into the liquid to be pumped. The submergence of the suction pipe into the liquid should be at least four to five times the pipe diameter. If this is not possible, provide a baffle or a floating board. This is to prevent any vortex action allowing air into the pipe/hose. For best performance, a bell mouth fitting is recommended. Recommended pipe submergences for various flows as well as recommended bell diameters are shown in the table below. The table data is referenced from ANSI/HI 9.8-1998.

FLOW (GPN)	500	1000	1500	2000	2500	3000	3500	4000	4500
SUMMERGENCE WITH BELL (FT)									
Bell Diameter (in)	6.1	8.6	10.6	12.2	13.6	14.9	16.1	17.2	18.3
Submergence (ft)	2.1	2.6	3.0	3.3	3.5	3.7	3.9	4.1	4.3
SUBMERGENCE WITHOUT BELL (FT)									
PIPE ID (in) - No Bell	SUBMERGENCE WITHOUT BELL (FT)								
3	4.7								
4	3.3	6.3							

FLOW (GPN)	500	1000	1500	2000	2500	3000	3500	4000	4500
6	2.1	3.7	5.3						
8	1.7	2.8	3.8	4.9	6.0				
10	1.6	2.3	3.1	3.8	4.6	5.4	6.1	6.9	7.6

- Attach a flexible hose to the outlet (discharge) side of the pump. Make sure the O-ring seal is present in the fitting on the pump before attaching the fitting. **Note:** Lubricate the O-ring seal with grease to ensure an airtight seal. Use a concentric taper on the discharge side to increase discharge pipe/hose diameters. All valving and additional fittings should be the same size as the discharge main-line. The discharge size should be adequate to maintain reasonable velocities and reduce friction losses. It is strongly recommended that a pressure relief valve is installed on the discharge piping.
- Check the intake and outlet hoses for sharp bends or kinks that may restrict pump flow before proceeding. The intake hose should slope upwards toward the pump to avoid development of air pockets in the hose which may lead to pump cavitation. Keep the hoses as straight as possible.
- The pump is self-priming, but should never be operated unless there is liquid in the pump casing. The pump casing needs to be half filled with liquid in order to prime. Remove the cover from the top of the pump volute and fill the pump casing with water.

Note: The casing will only fill to the bottom of the intake fitting, not to the top of the volute. Replace the cover and tighten the clamp screws hand tight.

▲ WARNING

The pump will not prime when dry. Extended operation of a dry pump will destroy the seal assembly. Make sure the pump casing is half filled with liquid when priming.

▲ WARNING

Never open the priming cover on a pump that is hot or that has been operated recently. Extreme pressure may have built up inside the pump volute. Opening the priming cover could cause serious injury.

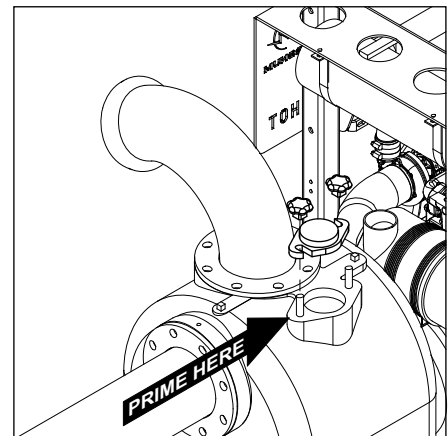

00429

▲ WARNING

Do not attempt to operate the pump unless all connecting piping, fill plug and other fittings are securely installed. Failure to do so could cause pumped liquid to be forced out under pressure, causing injury to personnel.

The pump is now ready for use.

STARTING THE PUMP

Before starting the pump, be sure to check the following:

- Make sure all hose couplings, covers and plugs are tight.
- Check the oil level in the mechanical seal oil reservoir bottle. Do not allow the bottle to run dry.
- The bearing oil and mechanical seal oil are each sealed by a shaft lip seal, and a vent to atmosphere exists between these two lip seals to indicate oil leaks from either cavity. If either the bearing oil or mechanical seal oil lip seal leaks, oil will leak from the vent. This vent should be checked for leakage prior to pump operation.

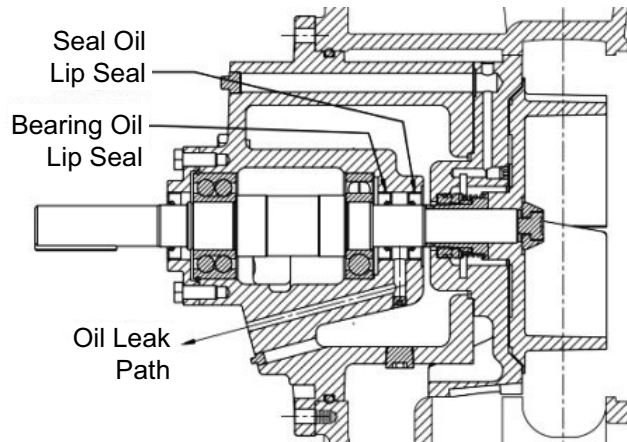

00430

- Check the engine oil level, coolant level and fuel level.
 - Make sure the engine starting battery is connected.
1. Make sure the Emergency Stop switch is pulled out (deactivated).
 2. Turn the Engine Start switch (key) to the right RUN position. A startup screen will appear. After the startup screen is cleared, the display will show readings on its virtual gauges. Once the gauges appear, crank the engine by turning and holding the key switch in the start position until the engine starts. Refer to [“Control Panel Operation” on page 15](#) for details.
 3. Allow the engine to run until it reaches a constant speed. Once it is running smoothly, the engine speed can be adjusted. To adjust the engine speed:
 - A. Loosen the locking ring on the throttle, located next to the mounting bracket, by turning counterclockwise.
 - B. Push and hold the center button on the throttle.
 - C. **PULL** the throttle out to **INCREASE** engine speed.
 - D. **PUSH** the throttle in to **DECREASE** engine speed.
 - E. Fine engine speed adjustment can be made by turning the throttle clockwise or counterclockwise.
 - F. Once the desired engine speed has been attained, lock the throttle by turning the locking ring clockwise.

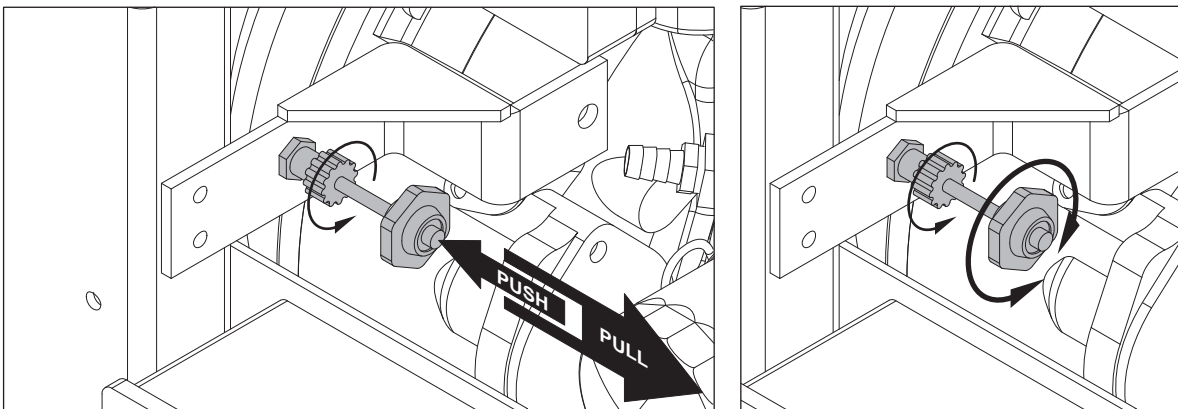

00431

4. The pump should self prime and begin to discharge liquid within minutes. The pump may not prime immediately because the suction line must first fill with liquid. If the pump fails to prime within five minutes, stop it and check the suction line for leaks.
5. Use the throttle to adjust the pump flow. Several factors can influence pump output:
 - The temperature, viscosity, and amount of entrapped solids in the liquid being moved.
 - The length, diameter, and number of bends of the intake and outlet hoses.
 - The total suction height (lift) of the pump.
 - The altitude above sea level where the pump is operating.

⚠ WARNING

Never adjust the pump flow by attaching a valve to the intake or outlet side of the pump. Restricting the flow in this way can cause the pump to overheat, creating extreme pressure inside the pump volute. Explosion of the pump volute and serious personal injury may result.

6. As the pump operates, avoid sucking and air/liquid mixture into the intake side of the pump as this may cause the pump to cavitate, causing damage to the pump impeller. The intake hose must be kept 4-5 times the hose diameter (4-5 x 6 in = 24-30 in [4-5 x 15 cm = 61-76 cm]) below the surface of the liquid being pumped.
7. Use the table below for approximate flow rates for the 6 in (15 cm) pump.

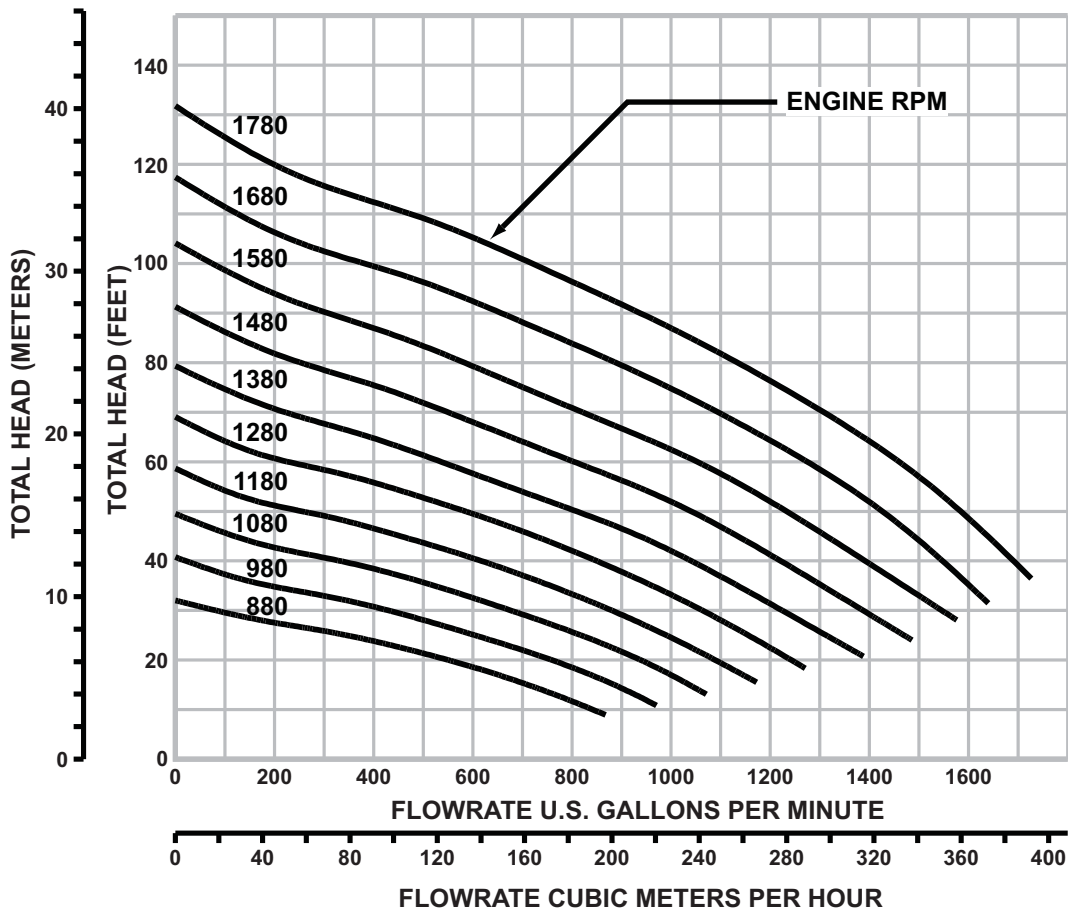

00432

SUCTION SPECIFICATIONS

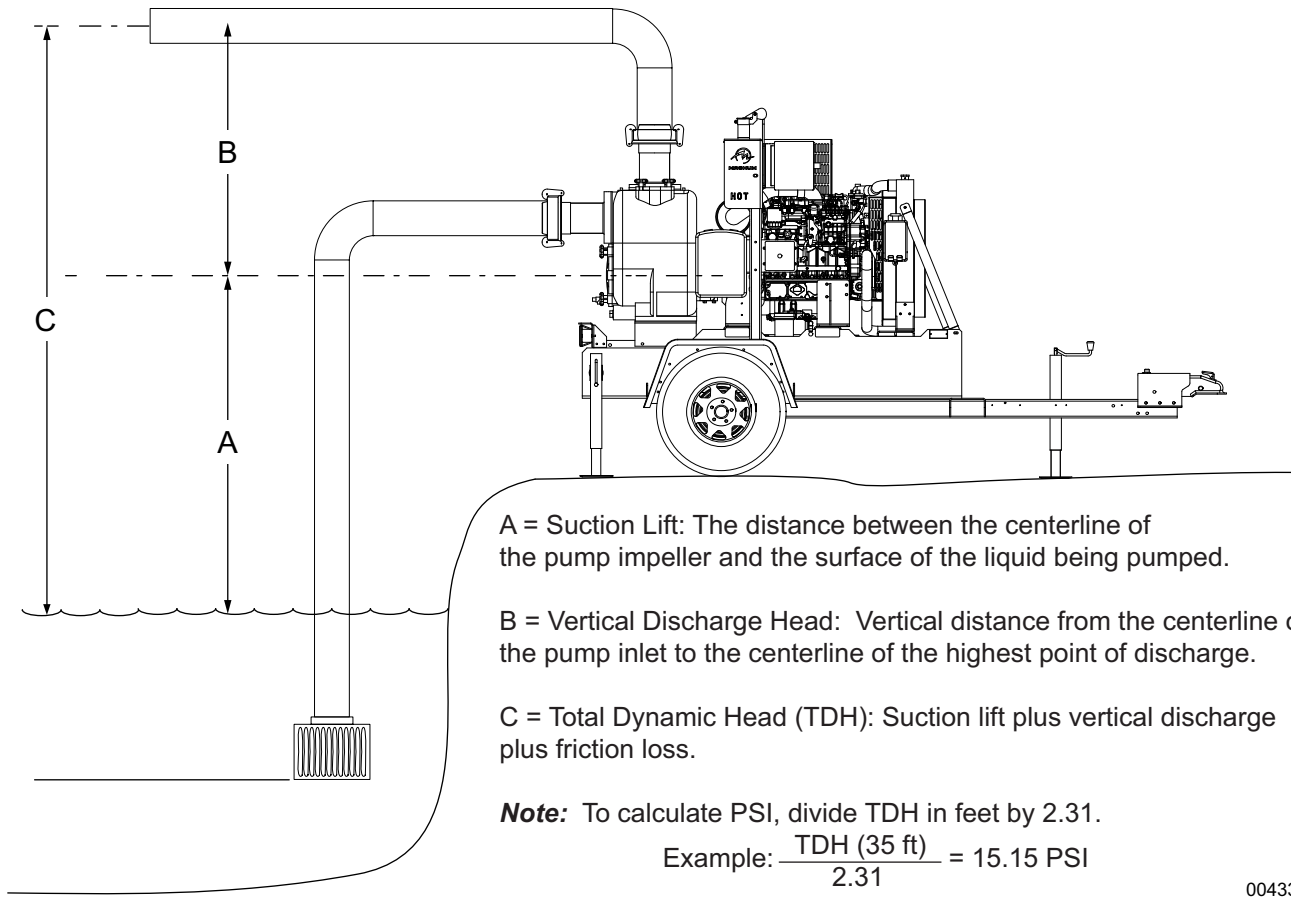

00433

LIQUID TEMPERATURE AND OVERHEATING

The maximum liquid temperature for this pump is 160°F (71°C). Do not apply it at a higher operating temperature.

Overheating can occur if the pump is operated with the valves in the suction and/or discharge lines closed. Operating against closed valves could bring the liquid to a boil, build pressure, and cause the pump to rupture or explode. If overheating occurs, stop the pump and allow it to cool before servicing it. Refill the pump casing with cool liquid. As a safeguard against rupture or explosion due to heat, this pump is equipped with a pressure relief valve that will open if vapor pressure within the pump casing reaches a critical point. **APPROACH ANY OVERHEATED PUMP CAUTIOUSLY.** It is recommended that the pressure relief valve assembly be replaced at each overhaul, or any time the pump casing overheats and activates the valve.

PUMP VACUUM CHECK

With the pump inoperative, install a vacuum gauge in the system. Make sure the pump is at least half filled with liquid. Block the suction line and start the pump. At operating speed, the pump should pull a vacuum of 20 in. (67728 Pa) of mercury or more. If it does not, check for air leaks at the suction piping gaskets.

BEARING TEMPERATURE CHECK

Bearings normally run at higher than ambient temperatures because of heat generated by friction. Temperatures up to 160°F (71°C) are considered normal for bearings, and they can operate safely to at least 180°F (82°C). Measure the bearing temperature with a contact-type thermometer.

STOPPING THE PUMP

1. Reduce the engine speed by adjusting the throttle.
2. Allow the engine to idle briefly before switching the engine start switch to the “OFF” position.

NOTICE

Do not use the emergency stop switch unless absolutely necessary. Stopping the pump suddenly may cause shock waves to be transmitted back to the pump volute, causing pump damage. To activate the emergency stop, push the stop switch in. To deactivate the switch, pull the switch out.

3. The pump is adequately prepared for outside storage. Refer to [“Storage” on page 52](#) for additional extended storage suggestions.

NOTICE

If the pump is to remain idle during below freezing conditions, drain the pump to prevent damage from freezing. Also, clean out any solids by flushing with a hose.

AUTOMATIC SHUTDOWN

The pump is equipped with a low oil pressure and a high temperature automatic shutdown system. This system will automatically shut off the fuel supply to stop the engine if oil pressure drops too low or the engine exceeds normal operating temperature. Return the engine start switch to the “OFF” position to reset the controller; restart the pump engine after you have determined the cause of the shutdown. Refer to [“Engine Fault Shutdown Troubleshooting” on page 55](#) for more information.

REMOTE/AUTO STARTING OPTION

The pump can be configured to start automatically by changing out the control box and adding dry-contact closure float level switches. Contact the Magnum Power Products LLC Technical Service Department at 1-800-926-9768 for more information on this option.

TOWING THE TRAILER

1. Raise the rear leveling jacks. Release the jack locking pins and rotate the jacks into the travel position.
2. Use the tongue jack to raise or lower the trailer onto the hitch of the towing vehicle. Lock the hitch coupling and attach the safety chains or cables to the vehicle. Release the jack locking pin and rotate the jack into the travel position. Make sure the locking pin snaps into place.
3. Connect any trailer wiring to the tow vehicle. Check for proper operation of the stop and signal lights.
4. Check for proper inflation of the trailer tires. Refer to [“Specifications” on page 11](#) for appropriate tire pressure.
5. Check the wheel lugs. Tighten or replace any that are loose or missing. If a tire has been removed for axle service or replacement, tighten the lugs in the order shown to the following specifications:

- A. Start all lug nuts by hand.
- B. First pass tighten to 20-25 ft-lbs (27-33 Nm).
- C. Second pass tighten to 50-60 ft-lbs (67-81 Nm).
- D. Third pass tighten to 90-120 ft-lbs (122-162 Nm).

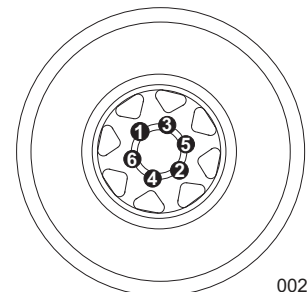

00205

Note: After the first road use, retorque the lug nuts in sequence.

6. Maximum recommended speed for highway towing is 45 mph (72 km/h). Recommended off-road towing speed is not to exceed 10 mph (16 km/h) or less, depending on terrain.

TRAILER WHEEL BEARINGS

The trailer axles are equipped with a grease zerk fitting to allow lubrication of the wheel bearings without the need to disassemble the axle hub. To lubricate the axle bearings, remove the small rubber plug on the grease cap, attach a standard grease gun fitting to the grease zerk fitting and pump grease into the fitting until new grease is visible around the nozzle of the grease gun. Use only a high quality grease made specifically for lubrication of wheel bearings. Wipe any excess grease from the hub with a clean cloth and replace the rubber plug when finished. The minimum recommended lubrication is every 12 months or 12,000 miles (19,312 km). More frequent lubrication may be required under extremely dusty or damp operating conditions.

LIFTING THE PUMP

Remove suction and discharge piping from pump prior to moving. Make sure the equipment being used to lift the unit is in good condition and has sufficient capacity. **Note:** Refer to “Specifications” on page 11 for approximate weights. Always remain aware of the position of other people and objects around you as you move the unit.

A central lifting eye is located on the top of the unit. Attach any slings, chains or hooks directly to the central lifting eye. Use the forklift pockets with care. Approach the unit as perpendicular as possible to avoid any damage to the unit. Make sure any obstructions are clear of the forklift tines before lifting.

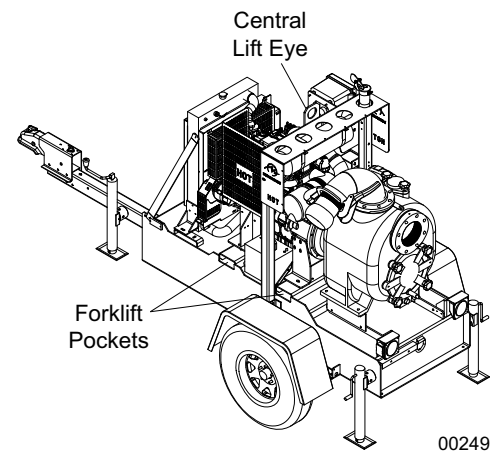

00249

DAILY WALK AROUND INSPECTION

Look for conditions that could hinder performance or safety, such as (but not limited to) oil/coolant/fuel leakage, blocked vents, loose/missing hardware and electrical connections.

Visually inspect the engine fan belt for cracks, fraying, stretching and that the belt is properly seated in pulley grooves. Replace the belt according to the manufacturer’s recommendations.

Note: At the 500 hour/12 month service interval, it is recommended that the belt be replaced. While the belt is removed, inspect pulleys and bearings. Rotate and feel for hard turning or unusual sounds.

NOTICE

Failure to perform a daily inspection may result in serious damage to the prime mover.

ENGINE AND PUMP MAINTENANCE

Poorly maintained equipment can become a safety hazard. In order for the equipment to operate safely and properly over a long period of time, periodic maintenance and occasional repairs are necessary. **NEVER** perform even routine service (oil/filter changes, cleaning, etc.) unless the engine start switch is turned to off “O” and the negative (-) cable on the battery is disconnected. Attach a “DO NOT START” sign to the control panel. This will notify everyone that the unit is being serviced and will reduce the chance of someone inadvertently trying to start the unit.

Never wash the unit with a high pressure hose or with any kind of power washer. Never wash the engine block or fuel tank with a power washer or steam cleaner. Water may collect in the pump control panel or other electrical parts, causing damage.

BASIC MAINTENANCE SCHEDULE (KUBOTA ENGINE)

NOTICE

Refer to the original equipment manufacturer's operating manual for a complete list of maintenance requirements. Failure to comply with the procedures as described in the engine operator manual will nullify the warranty, decrease performance and cause equipment damage or premature equipment failure. Maintenance records may be required to complete a warranty request.

Use the schedule in the following table as a guide for regular maintenance intervals. For additional or replacement copies of the engine operator's manual, contact an authorized dealer in your area.

Maintenance Action	Daily	50 Hrs	250 Hrs	500 Hrs	1 Year	2000 Hrs	2 Years
Check oil level	◆						
Check coolant level	◆						
Check fuel level	◆						
Check tire pressure	◆						
Check all electrical connections	◆						
Inspect radiator fins for debris, clean as required	◆						
Check mechanical seal oil level (page 52)	◆						
Check flange fitting hardware	◆						
Check condition of wear plate		◆					
Check fuel pipes and clamp bands		◆					
Drain water separator		◆					
Change engine oil		◆*	◆*				
Change mechanical seal oil (page 52)			◆				
Check condition of volute seals			◆				
Lubricate pump bearings (page 52)			◆				
Clean air cleaner element			◆				
Clean fuel filter			◆				
Check fan belt tightness			◆				
Check radiator hoses and clamp bands			◆				
Check intake air line			◆				
Check compressor mounting hardware				◆			
Replace oil filter cartridge		◆*		◆*			
Replace fuel filter cartridge				◆			
Remove sediment in fuel tank				◆			
Clean water jacket (radiator interior)				◆			
Replace fan belt				◆			
Cleaning of water separator				◆			
Lubricate leveling jacks				◆			
Drain and refill the pump bearing housing				◆			
Replace air cleaner element					◆**		

Maintenance Action	Daily	50 Hrs	250 Hrs	500 Hrs	1 Year	2000 Hrs	2 Years
Check flex coupling condition						◆	
Check pump to engine hardware						◆	
Change radiator coolant (L.L.C.)							◆
Replace radiator hoses and clamp bands							◆

* Change the engine oil and oil filter after the initial 50 hours of operation, then at the appropriate interval thereafter.

** Replace the air cleaner element yearly, or after six cleanings, whichever occurs first.

SERVICING THE UNIT

Poorly maintained equipment can become a safety hazard. In order for the equipment to operate safely and properly over a long period of time, periodic maintenance and occasional repairs are necessary. **NEVER** perform even routine service (oil/filter changes, cleaning, etc.) unless the engine start switch is turned to off “O” and the negative (-) cable on the battery is disconnected. Attach a “DO NOT START” sign to the control panel. This will notify everyone that the unit is being serviced and will reduce the chance of someone inadvertently trying to start the unit. Make sure engine and pump components are adequately cooled before attempting any service or maintenance work.

For detailed engine maintenance procedures, refer to the engine operator’s manual, which was supplied with the unit when it was shipped from the factory.

▲ WARNING

Before attempting to service the pump, read this manual carefully. Also review all tags and labels/decals provided on the equipment. Operating and maintenance personnel should have a good understanding of all aspects of this pump and the pumping conditions. Failure of operating personnel to be familiar with all aspects of pump operation outlined in this manual could contribute to equipment damage, bodily injury or possible death.

Before servicing:

1. Verify that the engine start switch is turned to OFF and the negative (-) cable on the battery is disconnected.
2. If the pump or components are hot, allow adequate cooling prior to servicing the unit.
3. Close the suction and discharge valves.
4. Vent the pump slowly and drain completely.

▲ WARNING

If this pump is used to handle any hazardous materials that can cause injury or illness, take precautions by wearing approved protective clothing and use appropriate safety equipment.

▲ WARNING

Use lifting and moving equipment that is in good condition and that has adequate capacity to prevent personal injury or equipment damage. When lifting the pump end with chains or cables, position them so the load is balanced and so pump damage will not occur. Suction and discharge hoses and piping must be removed from the pump before lifting.

When servicing this pump, use only components provided by Magnum Power Products LLC. Any use of non-authorized parts could result in sub-standard performance, damage to equipment and possible injury to personnel. Use of unauthorized parts will also void the warranty. Refer to [“Pump Components” on page 57](#).

Refer to the troubleshooting section on [page 54](#) to help diagnose operational or performance problems. Only

disassemble the pump components required to remedy the problem condition. Select a clean suitable location for any required maintenance, and note that all work must be performed by qualified personnel.

PUMP DISASSEMBLY

Under normal conditions this pump is designed to run maintenance free, because of its rugged construction, for extended periods of time. However, all centrifugal pumps contain wear parts that will gradually deteriorate, affecting pump performance. This pump does contain wear parts and these parts should be replaced as required to maintain optimum performance.

General maintenance can be performed without removing the pump from the engine. The following instructions assume a complete disassembly of the pump is required.

INSPECTION COVER AND WEAR PLATE

Once the pump has been drained, clean the drain plug and reinstall into inspection cover. Remove the four hand lugs and use the two jack screws provided to remove the inspection cover and assembled wear plate. Replace the wear plate if it is badly worn or scored. To remove the wear plate, remove the four nuts. Inspect the inspection cover O-rings and replace if necessary.

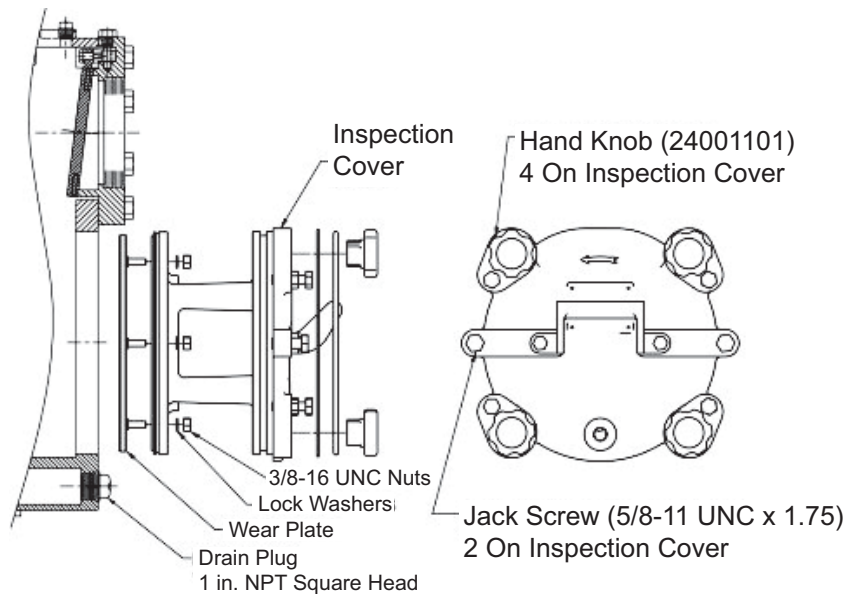

00434

SUCTION CHECK VALVE

With the inspection cover removed, the check valve can be accessed without removing the suction piping. To service the check valve assembly, remove the check valve bolt, reach through the inspection cover opening and pull the complete assembly from the suction flange. Service the check valve as required.

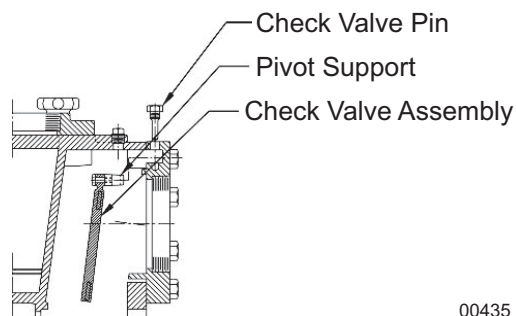

00435

ROTATING ASSEMBLY

The power source must be removed prior to removing the rotating assembly. Drain the oil in the seal cavity by removing the seal cavity drain plug. Clean and replace the drain plug after draining seal cavity of oil. Remove the four nuts on the studs of the volute, and use the two jack screws to remove the rotating assembly from the volute. Separate the rotating assembly by pulling straight away from the pump casing.

DRAIN PLUG ILLUSTRATION

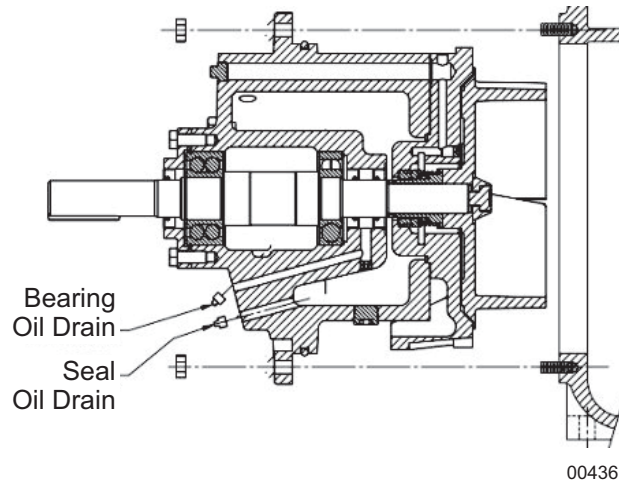

IMPELLER

With the rotating assembly removed from the pump casing, remove the impeller lock screw and unscrew the impeller from the shaft. The impeller was installed at the factory using Loctite® and so may be fairly difficult to unscrew. A propane torch can be used to ease loosening the screw if necessary. Use the impeller removal tool to fix the shaft from rotating, and use a metal bar or piece of wood to rotate the impeller counter-clockwise until it is free of the shaft. It may be necessary to pound the bar with a hammer to loosen the impeller. Inspect the impeller and replace as necessary. Use caution when removing the impeller.

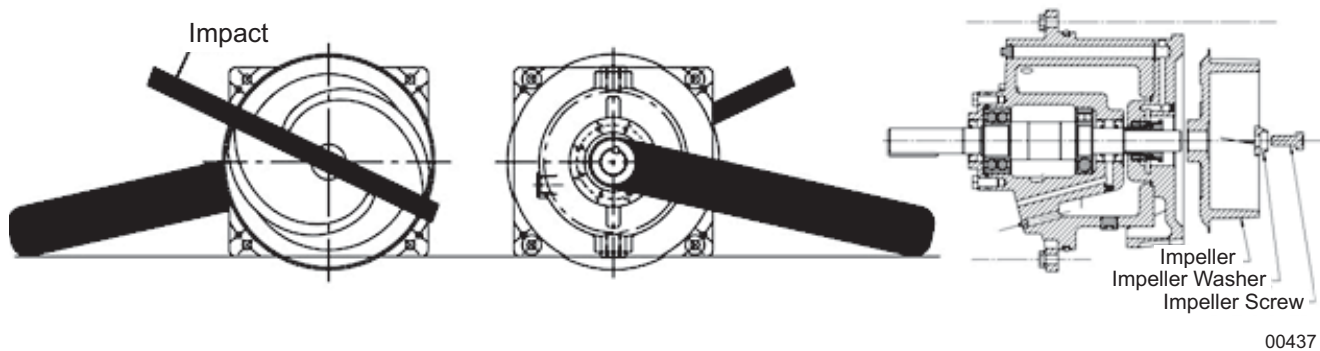

MECHANICAL SEAL

With the rotating assembly out of the volute and the impeller removed, slide the shaft sleeve and rotating portion of the seal off of the shaft as one unit. Drain the oil in the seal cavity by removing the seal cavity drain plug, located on the bearing housing's bottom front boss (Refer to Drain Plug Illustration, [page 48](#)). Clean and replace the drain plug after draining seal cavity of oil. Remove the seal housing from the bearing frame, and place it, face down, on a flat surface. With a suitable tool, press on the backside of the stationary seat until it is removed from the seal housing.

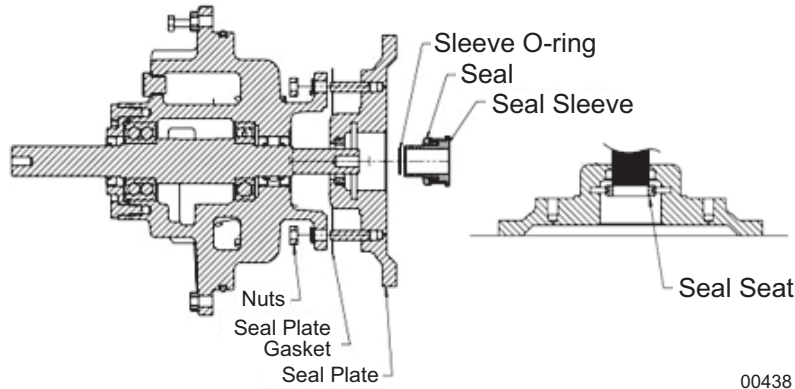

SHAFT AND BEARING

With the mechanical seal removed, remove the bearing housing drain plug located on the front bottom left of the bearing frame (Refer to Drain Plug Illustration, [page 48](#)) and drain oil. Clean plug and reinstall in housing. Remove fasteners, and slide the bearing cap/SAE bracket and grease seal off the shaft. Press the grease seal from the bearing cap/SAE bracket. Place a block of wood against the impeller end of the shaft and gently tap the shaft and bearings out of the housing.

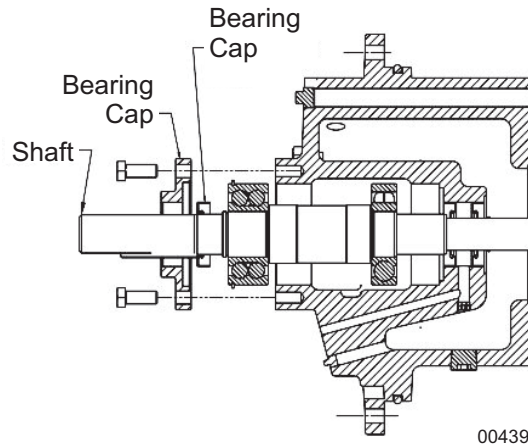

BEARING REMOVAL

Remove the shaft snap ring. This will require the use of snap ring pliers. It will be necessary to use a puller or hydraulic press to remove the drive end bearings and pump end bearing from the shaft. If the bearings are to be reused, be certain that puller jaws only bear against the inside races (shaft-side) of the bearings.

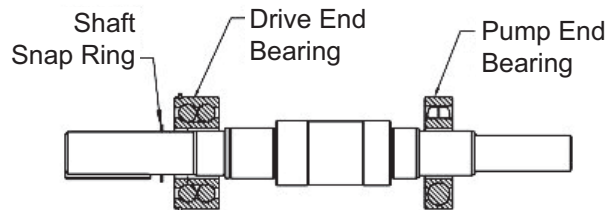

REASSEMBLY OF PUMP COMPONENTS

SHAFT AND BEARINGS

Clean the housing and components with an appropriate cleaning solvent and use compressed air to dry components. If bearings need replacement, remove the outboard (drive end) bearing retaining ring and use an appropriate bearing puller to remove bearings from shaft. Inspect shaft and replace if distorted, nicked or scratched beyond repair.

If bearings are to be replaced, then the bearings may be heated to 250°F (121°C) for ease of installation. An induction heater, electric oven or hot plate may be used to heat the bearings. Never use direct flame to heat bearings.

After heating the bearings, slide the bearings onto the appropriate shaft end. When installing the bearings onto the shaft, only press against the inner bearing race. The inboard bearing should be installed with the shielded side toward the impeller. The outboard bearing should have the integral retaining ring on the bearing outside diameter toward the drive end of the shaft.

After installation of bearing, ensure that bearings are tight against shaft shoulders. Secure the outboard bearing on the shaft with the bearing retaining ring. Slide the shaft and assembled bearings into the bearing housing until the retaining ring contacts the bearing housing.

SEAL INSTALLATION

A new seal assembly should be installed any time the old seal is removed. The wear pattern on the old seal can cause premature failure if reused. Thoroughly clean the shaft where the mechanical seal will be installed, and the seat of the seal housing. Place the sleeve O-ring over the shaft, past the threads and up against the shaft shoulder. Lubricate the stationary seat bore and stationary seat O-ring with P-80, 30 wt. motor oil, or liquid dish detergent and a little water. **DO NOT USE GREASE OR SILICONE LUBRICANTS.**

Remove the plastic, u-shaped seal-setting spacer from the cartridge seal assembly. Carefully slide the cartridge seal assembly over the shaft, with the stationary seat towards the bore. By hand only, carefully press on the flanged end of the cartridge seal sleeve until the stationary seat bottoms in the stationary seat bore. Install impeller according to instructions.

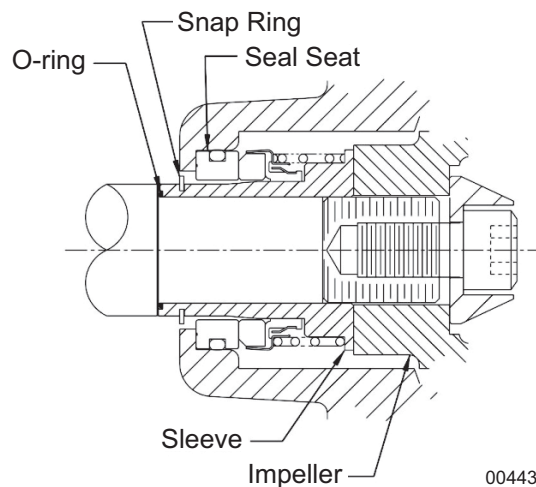

IMPELLER

The shaft and impeller threads must be completely clean before re-installing the impeller. Apply anti-seize compound to the external shaft threads. **DO NOT USE ANTI-SEIZE COMPOUNDS ON THE LOCKSCREW THREADS.** Screw the impeller onto the shaft until tight. A clearance of .025 to .035 in. (.63 to .89 mm) between the impeller and the seal plate is recommended for optimum pump efficiency.

Measure this clearance between the impeller and the rotating assembly with the rotating assembly sitting on the impeller with the shaft oriented vertically. Add or remove impeller adjusting shims as required to achieve the correct clearance. Apply Loctite 2760®, or equivalent thread locking compound, to impeller screw and install impeller washer and screw.

Torque the impeller screw to a minimum of 175 ft-lb (237 Nm), maximum of 235 ft-lb (118 Nm). Do not allow the shaft to rotate while tightening the lockscrew.

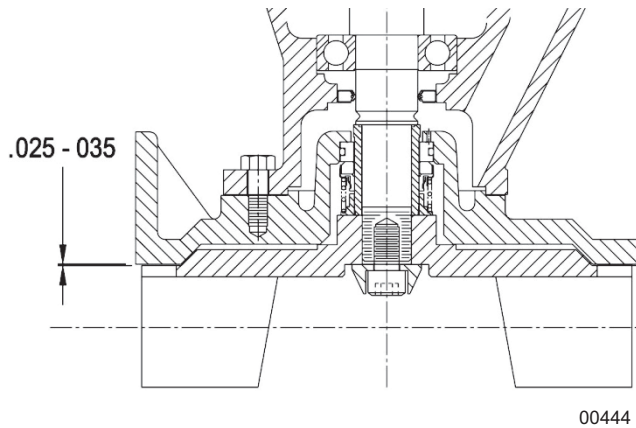

INSPECTION COVER AND WEAR PLATE

Re-grease the O-ring when installing and use 2760 Loctite® (red), or equivalent, on the wear plate studs. Installation is the reverse of removal.

ROTATING ASSEMBLY

Re-grease the O-ring and install rotating assembly into volute. Installation is the reverse of removal. Upon installation, the clearance between the suction cover and impeller needs to be verified. After sliding the rotating assembly back into the volute, evenly tighten rotating element bearing housing fasteners until impeller lightly contacts wear plate. **Note:** *The shaft will not rotate.* Tighten bearing housing jack screws until $.010$ to $.020$ in. ($.254$ to $.508$ mm) increase in clearance is achieved.

The clearance can be determined by taking measurements of the gap between the pump casing and the bearing housing when the impeller is making contact with the wear plate, then re-measure the same gap until the above increase in clearance is achieved at each corner of the bearing housing.

Rotate shaft, making sure there isn't any impeller/wear plate contact or rubbing. Tighten the jack screws at each corner of the bearing housing (not too tight), then tighten the jack screw lock nuts to maintain setting position. Rotate shaft to verify the shaft is free to rotate without the impeller rubbing on the wear plate. If the impeller continues to rub on the wear plate, repeat adjustment procedure above until the shaft rotates freely.

INSPECTION COVER AND WEAR PLATE ADJUSTMENT

The wear plate clearance can be opened on the ES-series without removing the rotating assembly by loosening the four hand knobs and tightening the four jack screws. Then re-tighten the hand knobs. The adjustment distance can be measured by comparing the before and after gap between the adjustment flange and the volute casing.

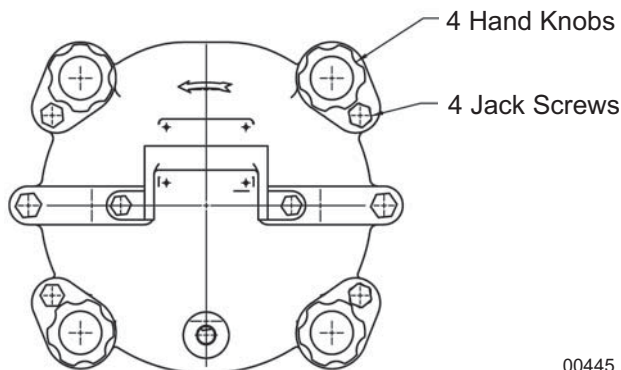

PRESSURE RELIEF VALVE

The suction cover is equipped with a pressure relief valve to provide additional safety for the pump and operator. Make sure the relief valve is set to 80 psi (551 kPa).

⚠ DANGER

IT IS RECOMMENDED THAT THE PRESSURE RELIEF VALVE ASSEMBLY BE REPLACED AT EACH OVERHAUL, OR ANY TIME THE PUMP OVERHEATS AND ACTIVATES THE VALVE. PERIODICALLY, THE VALVE SHOULD BE REMOVED FOR INSPECTION AND CLEANING. FAILURE TO FOLLOW THESE INSTRUCTIONS COULD RESULT IN SERIOUS PERSONAL INJURY.

PUMP LUBRICATION

Proper lubrication is essential to maintain performance and to help ensure trouble free operation.

MECHANICAL SEAL ASSEMBLY

Prior to starting the pump, remove the seal vent plug and fill the seal cavity with approximately one quart (33 oz) of ISO VG 32 viscosity grade 32 turbine oil, so that the oil level is halfway in the level sight gauge.

BEARINGS

The bearing housing was lubricated at the factory and should be maintained at the middle of the sight gauge. Use an ISO viscosity grade 32 Turbine oil and fill through the air vent hole at the top right of the bearing frame. Under normal use, drain and refill bearing housing at least once every 12 months.

⚠ CAUTION

Over-filling the oil can result in premature failure of bearings.

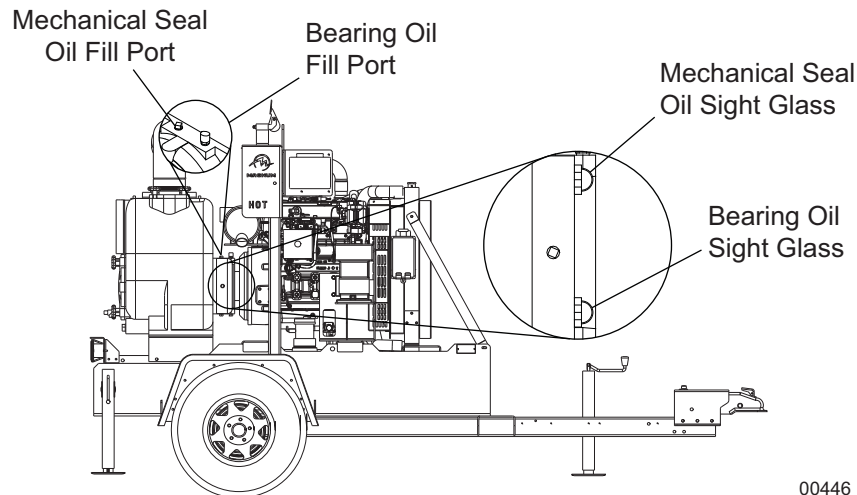

STORAGE

The unit is adequately prepared for outside storage prior to shipment. Use the following list of additional suggestions for extended storage.

1. Disconnect the battery cables.
2. Store the unit off the ground so no water will accumulate around the equipment.
3. Protect unit from blowing sand and dirt.
4. Stack no other items on top of pump/equipment.

5. Protect unit from the entry of any animals.
6. Periodically rotate shaft to lubricate bearings and protect bearings from brinelling.
7. Protect unit with approved drying agents (Silica Gel).
8. Ensure all bare metal areas are coated with a rust preventative.
9. Inspect unit every four weeks and replace drying agents (Silica Gel) as required, or a minimum of every six months.
10. Keep an inspection record showing dates of inspection with any maintenance performed and condition of drying agents (Silica Gel).
11. Before use ensure that all rust protection has been removed. Also, remove any foreign material that may have accumulated during storage.
12. Before use remove all drying agents (Silica Gel).

PRODUCT FLUSH OPTION

With the throttle bushing installed, remove the .5 in. NPT pipe plug above the shaft at the drive end of the bearing housing. Connect a water source to the .5 in. NPT port that maintains no less than 50% of the discharge pressure. Water will flow through the seal housing into the pumpage to keep it from entering the seal housing.

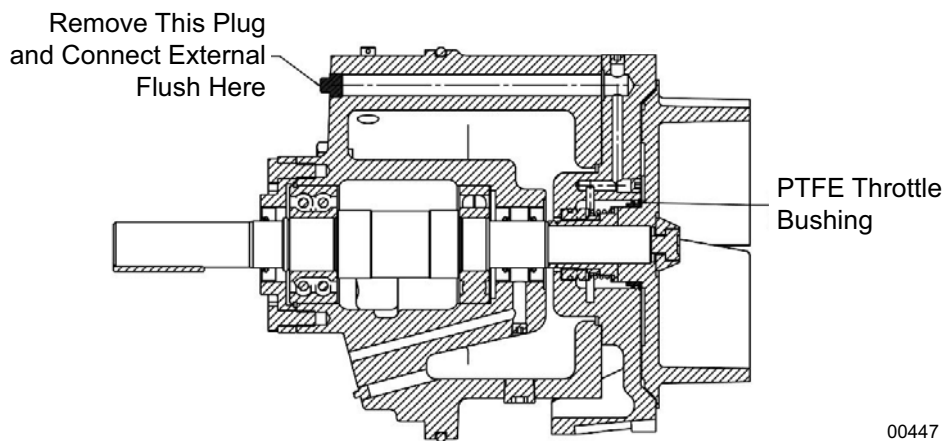

00447

PUMP TROUBLESHOOTING

Symptom	Possible Cause
No discharge	1,2,3,4,5,7,8,9,10,17,18,19,20,37,49
Reduced capacity	2,3,4,5,7,8,9,10,11,17,19,20,21,38,39,40,47,49
Reduced pressure	5,7,8,11,13,18,19,38,39,40,47,49
Loss of prime	2,3,4,7,10,11,20,21,22,23,49
Power consumption excessive, engine runs hot	6,12,13,17,18,19,24,33,34,35,36,37,38,41,42,43,44
Pump fails prime	1,4,5,10,20,21,49,50,51
Vibration and noise	2,4,9,10,14,15,17,26,27,28,29,30,31,32,33,34,35,36,39,40,41,42,43,44,48,49
Seal: excessive leakage, short life, seal housing overheating	22,23,25,33,34,35,36,41,44,45,46
Bearings: overheating, short life, noise	26,27,28,29,30,31,32,33,34,35,36,41,42,43,44
Pump overheating, seizes	1,8,9,14,33,34,35,36,41,42,43,44
Corrosion, erosion, pitting, oxidation or other loss of material	7,8,11,14,15,16

- | | | |
|---|--|---|
| 1. Pump not primed | 16. Electrolysis | 34. Temperature growth |
| 2. Suction line not filled | 17. Impeller obstructed | 35. Misalignment |
| 3. Air pocket in suction line | 18. Wrong-rotation direction | 36. Coupling improperly installed |
| 4. Suction inlet or foot valve obstructed, insufficiently submerged, or too small | 19. Low speed | 37. Impeller installed backwards |
| 5. System head higher than pump design head | 20. Air leak into suction line | 38. Wear rings-worn |
| 6. System head lower than pump design head | 21. Air leak through mechanical seal | 39. Impeller damage |
| 7. Insufficient NPSH | 22. Seal fluid contaminated, hot or insufficient | 40. Improper balance (after repair) |
| 8. Parallel pump application is incorrect | 23. Seal fluid system not vented | 41. Bent shaft |
| 9. Suction pressure to vapor pressure below minimum | 24. High speed | 42. Excessive thrust |
| 10. Suction lift too high | 25. Mechanical seal insufficient | 43. Rotational element dragging |
| 11. Excess vapor in pumpage | 26. Bearing housing excessively cooled | 44. Worn or incorrectly installed bearings |
| 12. Specific gravity of pumpage housing different than design | 27. Low oil pressure (oil lube bearings) | 45. Mechanical seal not properly set, O-rings damaged or hardened |
| 13. Viscosity of pumpage different than design | 28. Improper or poor lubrication | 46. Shaft scored at seal |
| 14. Operation at below rated capacity | 29. Lubrication defective | 47. Volute O-ring |
| 15. Cavitation | 30. Dirt in lubrication/bearings | 48. Foundation not rigid or settled |
| | 31. Moisture in lubricant/bearing housing | 49. Suction line collapsed |
| | 32. Lubricant excess | 50. Not enough liquid in casing |
| | 33. Pipe strain | 51. Suction check valve contaminated or damaged |

ENGINE FAULT SHUTDOWN TROUBLESHOOTING

Symptom	Possible Cause	Solution
Low oil pressure shutdown	Low oil level	Check oil level, replace as necessary
	Faulty oil pressure sender	Replace oil pressure sender
	Incorrect oil grade	Change engine oil, consult engine operating manual
	Worn oil pump	Consult engine operating manual
	Oil leak	Consult engine operating manual
High temperature shutdown	Low coolant level	Check coolant level, replace as necessary
	Faulty temperature sender	Replace temperature sender
	Coolant leaks	Consult engine operating manual, replace components as necessary
	Worn water pump	Consult engine operating manual
Overcrank shutdown	Pump engine will not start	Consult engine operating manual
Overspeed shutdown	Pump cavitation	Reduce engine speed, lower intake hose
	Air trapped in intake hose	Relocate and/or straighten intake hose
	Intake insufficiently submerged	Lower intake hose
	Air leak in intake hose	Inspect intake hoses and couplings for damage or missing components and seals
	Air leak at pump housing	Inspect gaskets, seals and O-rings at pump intake flange, cleanout cover and priming port
No speed signal shutdown	Engine magnetic pickup damaged or misaligned	Inspect magnetic pickup for damage/alignment
Low fuel shutdown	Low fuel level	Refill fuel tank with clean diesel fuel
Low coolant shutdown	Low coolant level	Allow engine to cool. Check coolant level in radiator. Add coolant until it is 3/4 in. (19 mm) below the filler neck

CONTROL SYSTEM TROUBLESHOOTING

Symptom	Possible Cause	Solution
Control system does not perform self test	Tripped overcurrent protection	Correct fault, replace or reset overcurrent protection
	Faulty connection to battery	Correct battery connections
	Faulty control system	Repair or replace control system
Display does not display data	Display lost power	Turn on key, verify display plugged into harness
	Engine source address incorrect	Change engine address in <i>Configuration</i>
	Display address incorrect	Change display address to 40 (default)
	Display configuration problem	Reset display using <i>Restore Defaults</i>
	CANbus failure	Check CANbus (Refer to <i>Testing CANbus</i>)
	ECU not sending data	Repair or replace ECU

PUMP COMPONENTS

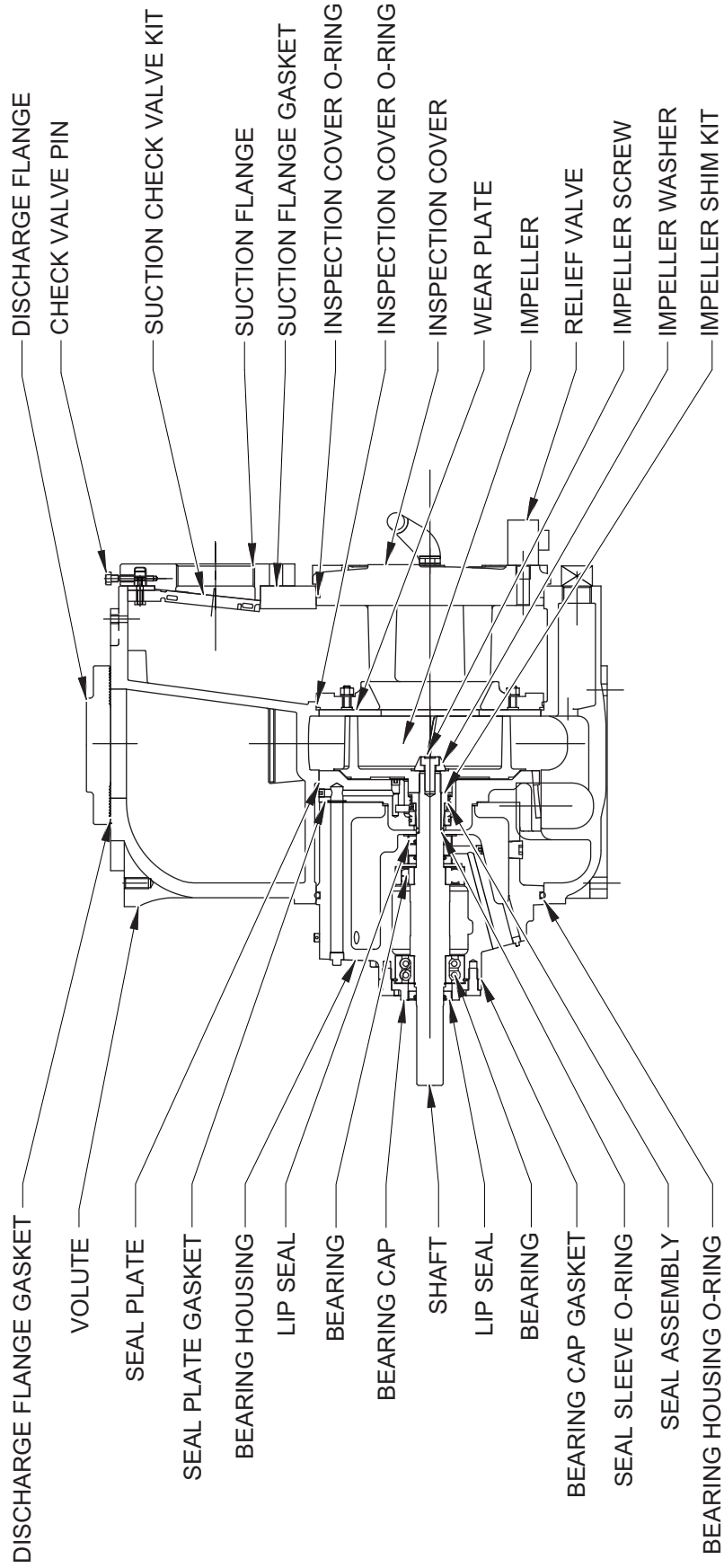

00448

DC WIRING DIAGRAM

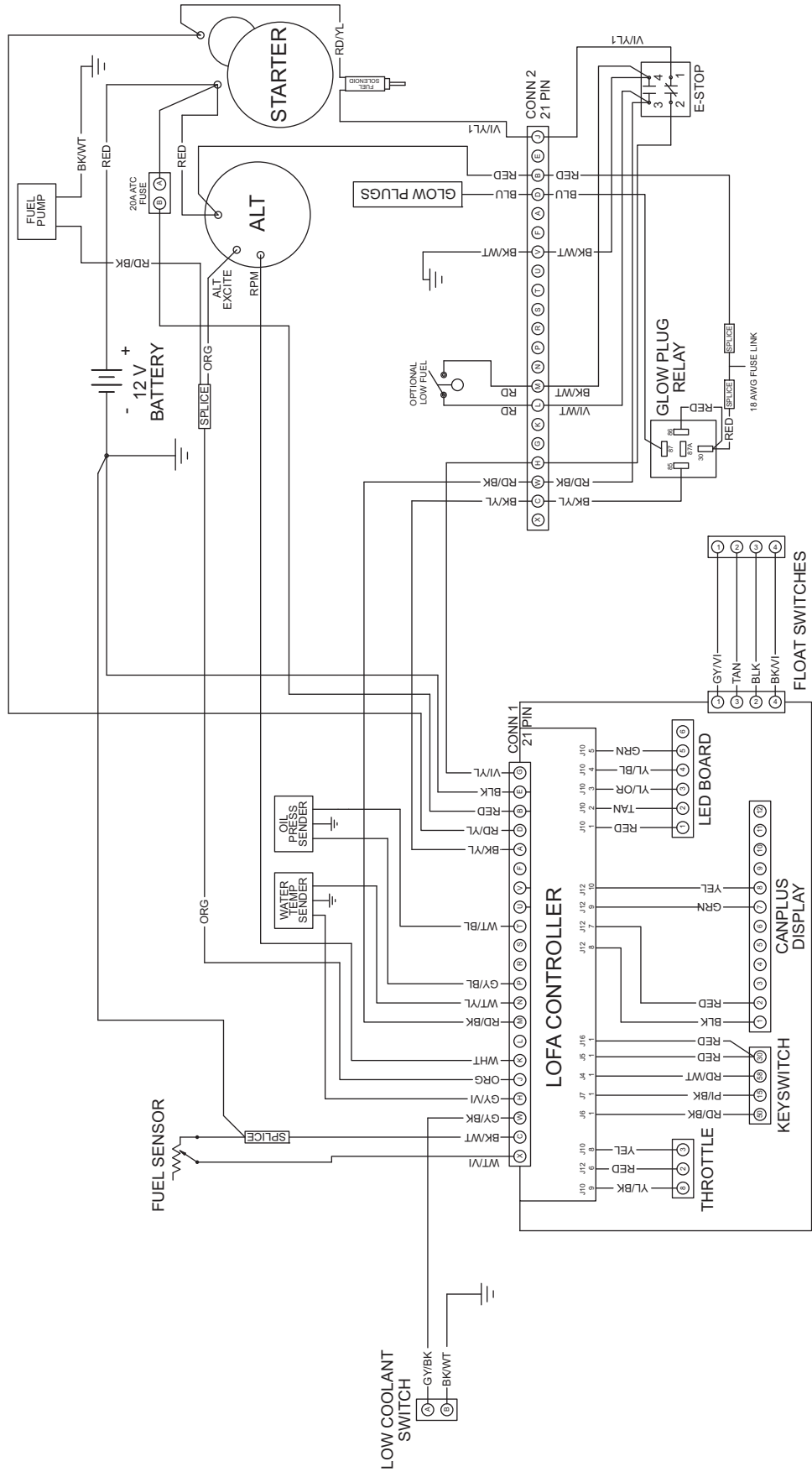

90294_E_08.19.13

TRAILER LIGHTS WIRING DIAGRAM

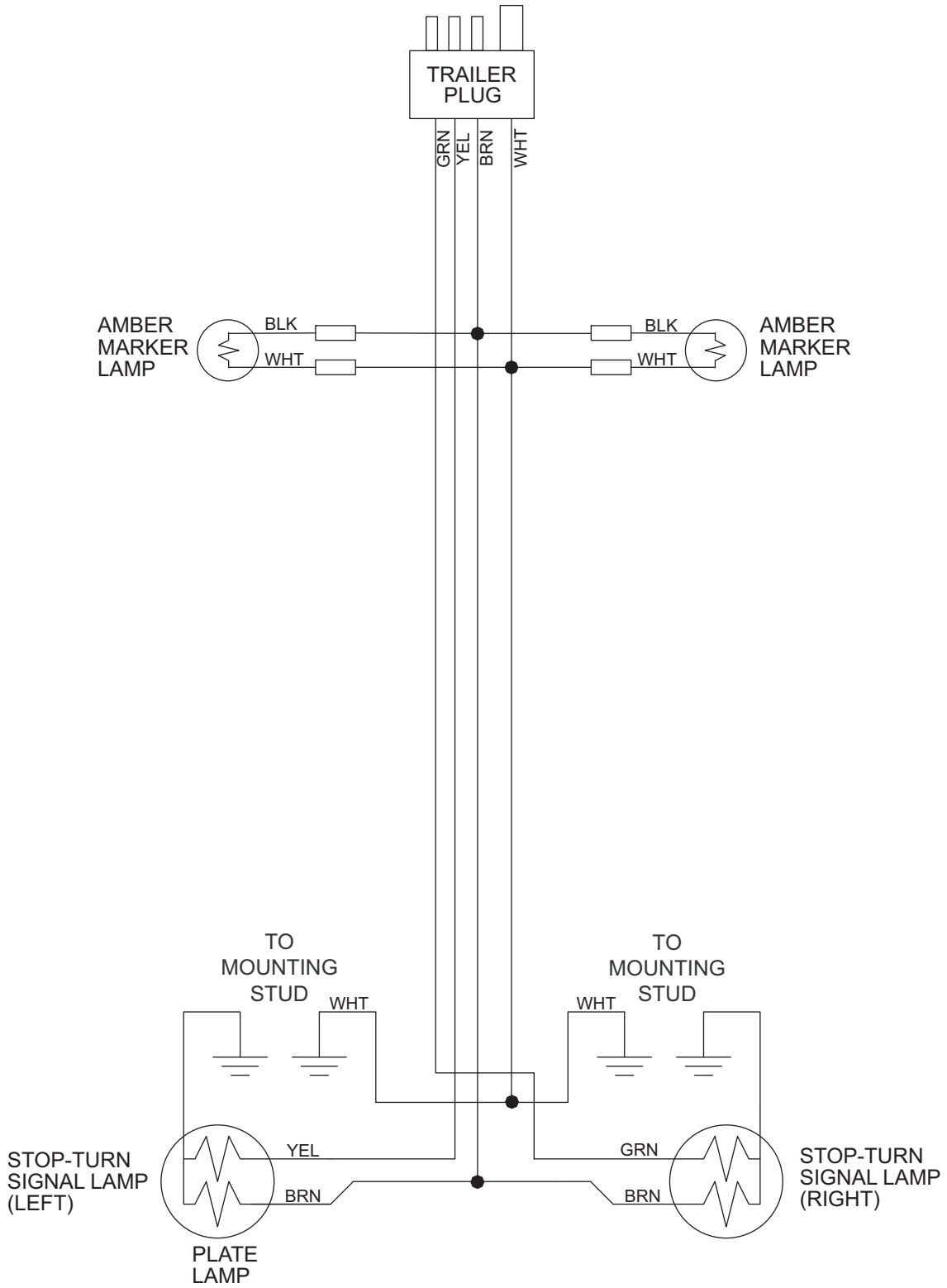

90228_ORG_05.09.12

BRAKE WIRING DIAGRAM

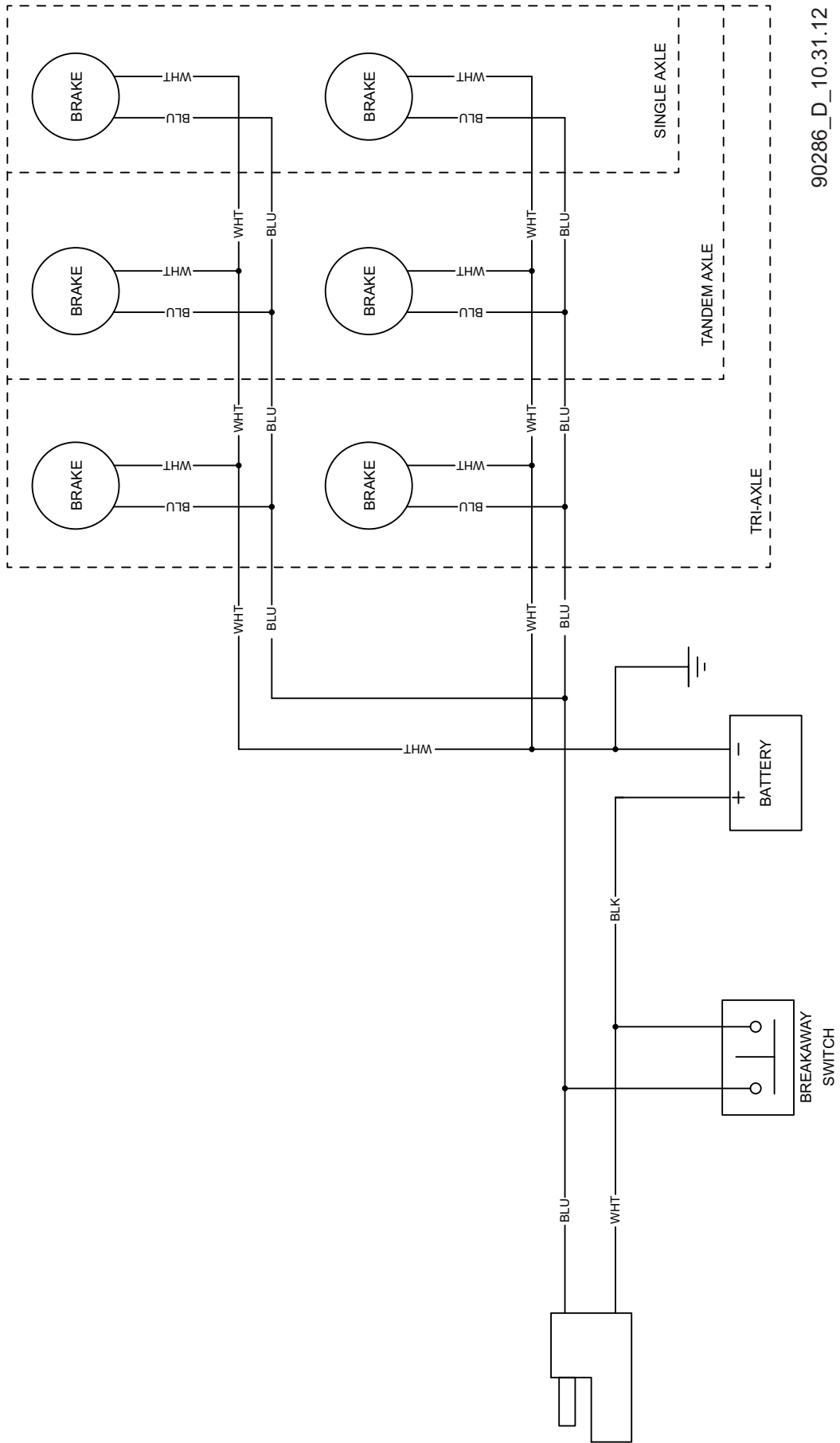

90286_D_10.31.12

SERVICE LOG

OIL GRADE: _____ BRAND: _____

COOLANT MIXTURE: _____ BRAND: _____

Date	Hours to service	Oil level	Coolant level

Date	Hours to service	Oil level	Coolant level

REV: B
PART NO: 32136
02.20.14

CANplus and CANplus logo are registered
trademarks of LOFA Industries, Inc.
CP600 is a trademark of LOFA Industries, Inc.